

Genuine Value Retail Sales Guide

manh truc[®] woven shade collection



October 10, 2017

Electronic Update: March 27, 2018

Prices subject to change without notice

Customer assumes all responsibilities for phone orders.
Due to custom nature of our business,
orders cannot be cancelled after materials have been cut.

Custom Crafted in the U.S.A.



 LAFAYETTE
interior fashions™

Table of Contents

Manh Truc Woven Collection

Manh Truc Woven Shade Collection Fabric Price/Product Index	3
Specification Summary - Standard Rectangular	4
Specification Summary - Options	5
CareRING Cordless Maximum Sizes	6-7
Specification Summary - Motorized	8-8C
Specification Summary - Roller Shades, Panel Track, Panel Drape, Grommet Panel	9
Specification Summary - Options Cross Reference	10
Pricing	
Roman Shade Pricing	11-13
Roman Shade Surcharges	14
Roman Shade Motorization Surcharges	15
Roller Shade Pricing	16-17
Panel Track Pricing and Surcharges	18-19
Panel Drape Pricing and Surcharges	20-21
Stationary Grommet Panel Pricing and Surcharges	22
Product Information	
Manh Truc Flat Roman Shades	23
Manh Truc Hobbled Roman Shades	24
Manh Truc Roman Shades with Clutch System	25
Manh Truc Roman Shades with CareRING Cordless	26
Manh Truc Roman Duo-Shades	27
Manh Truc Woven Shade Specialities	28
Manh Truc Somfy Motorization	29-29A
Manh Truc EZ Charge Motorization	29B
Manh Truc Auto-Wand™ Motorization	29-C
Manh Truc Woven Roller Shades	31
Manh Truc Woven Panel Track	32-34
Manh Truc Woven Panel Drape	35
Manh Truc Stationary Grommet Panel	36
Design Options	
Child Safety	37
Edge Banding	38
Lining	39
Top Down/Bottom Up	39
Multiple Shades on One Headrail	39
Valances & Tracks	40
Cornices	41
Miscellaneous	42
Measuring	43
Brackets, Care & Cleaning, Advisories	44
Color Listing	45
Perfectly Natural Insert	46
Warranty	47

* Click [BACK](#) on any page to return to the Table of Contents*

Fabric Price / Product Index

Manh Truc Woven Collection

Pattern Name	Flat Roman Chart	Hobbled Roman Chart	Edge Banding on Roman Shades	Roller Shade Chart	Panel Track Chart	Panel Drape Chart	Stationary Grommet Panels	Bottom Banding Panel Drape or Grommet Panel	# of Colors
Akela	F4	H4	Yes	N/A	N/A	PD4	G4	N/A	4
Aris	F2	H2	Yes	N/A	PT2	PD2	G2	Yes	1
Bacopa	F1	N/A	N/A	N/A	N/A	N/A	N/A	N/A	1
Batang	F1	H1	Yes	N/A	N/A	PD1	G1	Yes	1
Bayani	F2	H2	Yes	RL2	PT2	PD2	G2	Yes	1
Beijing	F3	H3	Yes	N/A	N/A	PD3	G3	Yes	2
Bengali	F5	H5	Required - Add Surcharge	N/A	PT5	PD5	G5	N/A	1
Caracas	F3	N/A	N/A	N/A	N/A	N/A	N/A	N/A	2
Chakra	F4	H4	Yes	N/A	N/A	N/A	N/A	N/A	5
Chinda	F3	H3	Yes	RL3	N/A	PD3	G3	N/A	4
Dieu	F2	H2	Yes	RL2	N/A	PD2	G2	Yes	2
Dynasty	F1	H1	Yes	RL1	PT1	PD1	G1	Yes	1
Hanoi	F5	N/A	Yes	N/A	PT5	PD5	G5	Yes	1
Jambu	F2	H2	Yes	RL2	PT2	PD2	G2	Yes	4
Jilin	F3	H3	Yes	N/A	PT3	PD3	G3	Yes	1
Kaila	F4	H4	Yes	RL4	N/A	PD4	G4	N/A	2
Kaliko	F5	H5	Yes	N/A	N/A	PD5	G5	N/A	4
Kato	F4	H4	Yes	N/A	N/A	PD4	G4	Yes	1
Kazuki	F4	H4	Yes	RL4	PT4	PD4	G4	Yes	1
Khan	F6	N/A	Required - Add Surcharge	N/A	N/A	N/A	N/A	N/A	1
Kwan	F5	H5	Yes	N/A	N/A	PD5	G5	N/A	1
Lada	F4	N/A	Required - Add Surcharge	N/A	N/A	N/A	N/A	N/A	1
Lani	F6	H6	Yes	N/A	N/A	PD6	G6	N/A	4
Lea	F6	H6	Yes	N/A	N/A	PD6	G6	N/A	3
Maka	F5	H5	Yes	N/A	N/A	PD5	G5	Yes	1
Malana	F6	H6	Required - Add Surcharge	N/A	N/A	PD6	G6	N/A	2
Malie	F5	H5	Required - Add Surcharge	N/A	N/A	PD5	G5	N/A	1
Miya	F5	H5	Yes	RL5	PT5	PD5	G5	N/A	4
Naoki	F1	H1	N/A	RL1	N/A	N/A	N/A	N/A	5
Okalani	F6	H6	Yes	N/A	N/A	PD6	G6	Yes	4
Osaka	F3	H3	Yes	RL3	PT3	PD3	G3	Yes	1
Sapporo	F1	H1	N/A	N/A	N/A	N/A	N/A	N/A	2
Sasarido	F4	H4	Yes	RL4	N/A	PD4	G4	Yes	1
Sibu	F3	N/A	Yes	N/A	N/A	N/A	N/A	N/A	1
Srilanka	F4	H4	Yes	N/A	N/A	N/A	N/A	N/A	1
Taipei	F2	H2	N/A	N/A	N/A	N/A	N/A	N/A	1
Taishan	F5	N/A	Yes	N/A	N/A	PD5	G5	Yes	1
Tomiko	F3	H3	Yes	N/A	PT3	PD3	G3	Yes	1
Ulani	F3	H3	Yes	RL3	PT3	PD3	G3	Yes	1
Waja	F4	H4	Yes	RL4	PT4	PD4	G4	Yes	3
Zhen	F4	N/A	Yes	N/A	N/A	N/A	N/A	N/A	1



FLT
Flat Roman



HOB
Hobbled Roman



ROL
Roller Shade



PTR
Panel Track



PDR
Panel Drape

Specification Summary

Manh Truc Roman Shades - Standard Rectangular

Maximum Sizes	Cordlock System				Clutch Systems				CareRING Cordless			
	Flat Roman		Hobbled Roman		Flat Roman		Hobbled Roman		Flat Unlined Size Chart	Flat LF Lining Size Chart	Flat OP Lining Size Chart	Hobbled Unlined Size Chart
	Width	Length	Width	Length	Width	Length	Width	Length				
Akela	118"	120"	118"	96"	118"	120"/96"*	118"	120"/96"*	CF1	LF1	OP1	CH1
Aris	118"	120"	118"	96"	118"	120"/96"*	118"	120"/96"*	CF2	LF2	OP2	CH2
Bacopa	96"	120"	N/A	N/A	96"	120"/96"*	N/A	N/A	CF4	LF4	OP4	N/A
Batang	96"	120"	96"	96"	96"	120"/96"*	96"	120"/96"*	CF2	LF2	OP2	CH2
Bayani	96"	120"	96"	96"	96"	120"/96"*	96"	120"/96"*	CF1	LF1	OP1	CH1
Beijing	95"	120"	95"	96"	95"	120"/96"*	95"	120"/96"*	CF1	LF1	OP1	CH1
Bengali	96"	120"	96"	96"	96"	120"/96"*	96"	120"/96"*	N/A	N/A	N/A	N/A
Caracas	72"	84"	N/A	N/A	72"	84"	N/A	N/A	N/A	N/A	N/A	N/A
Chakra	118"	120"	118"	96"	118"	120"/96"*	118"	120"/96"*	CF1	LF1	OP1	CH1
Chinda	118"	120"	118"	96"	118"	120"/96"*	118"	120"/96"*	CF1	LF1	OP1	CH1
Dieu	96"	120"	96"	96"	96"	120"/96"*	96"	120"/96"*	CF1	LF1	OP1	CH1
Dynasty	118"	120"	118"	96"	118"	120"/96"*	118"	120"/96"*	CF3	LF3	OP3	CH3
Hanoi	94"	120"	N/A	N/A	94"	120"/96"*	N/A	N/A	CF1	LF1	OP1	N/A
Jambu	118"	120"	118"	96"	118"	120"/96"*	118"	120"/96"*	CF2	LF2	OP2	CH2
Jilin	118"	120"	118"	96"	118"	120"/96"*	118"	120"/96"*	CF3	LF3	OP3	CH3
Kaila	72"	120"	72"	96"	72"	120"/96"*	72"	120"/96"*	CF1	LF1	OP1	CH1
Kaliko	96"	120"	96"	96"	96"	120"/96"*	96"	120"/96"*	CF1	LF1	OP1	CH1
Kato	96"	120"	96"	96"	96"	120"/96"*	96"	120"/96"*	CF1	LF1	OP1	CH1
Kazuki	96"	120"	96"	96"	96"	120"/96"*	96"	120"/96"*	CF1	LF1	OP1	CH1
Khan	96"	120"	N/A	N/A	96"	120"/96"*	N/A	N/A	N/A	N/A	N/A	N/A
Kwan	96"	120"	96"	96"	96"	120"/96"*	96"	120"/96"*	CF1	LF1	OP1	CH1
Lada	96"	120"	N/A	N/A	96"	120"/96"*	N/A	N/A	N/A	N/A	N/A	N/A
Lani	96"	120"	96"	96"	96"	120"/96"*	96"	120"/96"*	CF1	LF1	OP1	CH1
Lea	118"	120"	118"	96"	118"	120"/96"*	118"	120"/96"*	CF1	LF1	OP1	CH1
Maka	96"	120"	96"	96"	96"	120"/96"*	96"	120"/96"*	CF1	LF1	OP1	CH1
Malana	96"	120"	96"	96"	96"	120"/96"*	96"	120"/96"*	N/A	N/A	N/A	N/A
Malie	96"	120"	96"	96"	96"	120"/96"*	96"	120"/96"*	N/A	N/A	N/A	N/A
Miya	118"	120"	118"	96"	118"	120"/96"*	118"	120"/96"*	CF1	LF1	OP1	CH1
Naoki	118"	120"	118"	96"	118"	120"/96"*	118"	120"/96"*	CF2	LF2	OP2	CH2
Okalani	118"	120"	118"	96"	118"	120"/96"*	118"	120"/96"*	CF1	LF1	OP1	CH1
Osaka	96"	120"	96"	96"	96"	120"/96"*	96"	120"/96"*	CF1	LF1	OP1	CH1
Sapporo	96"	120"	96"	96"	96"	120"/96"*	96"	120"/96"*	CF1	LF1	OP1	CH1
Sasarido	96"	120"	96"	96"	96"	120"/96"*	96"	120"/96"*	CF3	LF3	OP3	CH3
Sibu	96"	120"	N/A	N/A	96"	120"/96"*	N/A	N/A	CF1	LF1	OP1	N/A
Srilanka	96"	120"	96"	96"	96"	120"/96"*	96"	120"/96"*	CF1	LF1	OP1	CH1
Taipei	96"	120"	96"	96"	96"	120"/96"*	96"	120"/96"*	CF4	LF4	OP4	CH4
Taishan	96"	120"	N/A	N/A	96"	120"/96"*	N/A	N/A	CF1	LF1	OP1	N/A
Tomiko	96"	120"	96"	96"	96"	120"/96"*	96"	120"/96"*	CF4	LF4	OP4	CH4
Ulani	96"	120"	96"	96"	96"	120"/96"*	96"	120"/96"*	CF1	LF1	OP1	CH1
Waja	118"	120"	118"	96"	118"	120"/96"*	118"	120"/96"*	CF1	LF1	OP1	CH1
Zhen	96"	120"	N/A	N/A	96"	120"/96"*	N/A	N/A	CF2	LF2	OP2	N/A
Minimum:	15"	30"	15"	30"	15"/24"*	30"	15"/24"*	30"	18 1/2"	26 1/2"	26 1/2"	26 1/2"

* Quick Lift Clutch has minimum width of 15" and max. length of 120"; Traditional Clutch has minimum width of 24" and max. length of 96".

Specification Summary

Manh Truc Roman Shades - Options

Maximum Sizes	2 on 1 or 3 on 1	Flat 2/3 on 1	Hobbled 2/3 on 1	Top Down/ Bottom Up		Flat Roman Duo Shade		Angle or Arch Top		Arch or Framed Arch		Hobbled Cornice		Waterfall Valance		Wood Bottom Hem
	Width	Length	Length	Width	Length	Width	Length	Width	Length	Width	Length	Width	Length	Width	Length	Width
Akela	144"	120"	96"	96"	108"	84"	96"	N/A	N/A	N/A	N/A	118"	12"	96"	36"	72"
Aris	144"	120"	96"	96"	108"	84"	96"	60"	108"	60"	30"	118"	12"	96"	36"	72"
Bacopa	144"	120"	N/A	96"	108"	84"	96"	N/A	N/A	N/A	N/A	N/A	N/A	N/A	N/A	72"
Batang	144"	120"	96"	96"	108"	84"	96"	60"	108"	60"	30"	96"	12"	96"	36"	72"
Bayani	144"	120"	96"	96"	108"	84"	96"	N/A	N/A	N/A	N/A	96"	12"	96"	36"	72"
Beijing	144"	120"	96"	95"	108"	84"	96"	N/A	N/A	N/A	N/A	118"	12"	95"	36"	72"
Bengali	144"	120"	96"	96"	108"	84"	96"	60"	108"	60"	30"	96"	12"	96"	36"	72"
Caracas	144"	84"	N/A	72"	84"	72"	84"	N/A	N/A	N/A	N/A	72"	12"	N/A	N/A	N/A
Chakra	144"	120"	96"	96"	108"	84"	96"	N/A	N/A	N/A	N/A	118"	12"	96"	36"	72"
Chinda	144"	120"	96"	96"	108"	84"	96"	N/A	N/A	N/A	N/A	118"	12"	96"	36"	72"
Dieu	144"	120"	96"	96"	108"	84"	96"	60"	108"	60"	30"	96"	12"	96"	36"	72"
Dynasty	144"	120"	96"	96"	108"	84"	96"	60"	108"	60"	30"	118"	12"	96"	36"	72"
Hanoi	144"	120"	N/A	94"	108"	84"	96"	60"	108"	60"	30"	N/A	N/A	94"	36"	72"
Jambu	144"	120"	96"	96"	108"	84"	96"	60"	108"	60"	30"	118"	12"	N/A	N/A	72"
Jilin	144"	120"	96"	96"	108"	84"	96"	60"	108"	60"	30"	118"	12"	96"	36"	72"
Kaila	144"	120"	96"	72"	108"	72"	96"	60"	108"	60"	30"	72"	12"	72"	36"	72"
Kaliko	144"	120"	96"	96"	108"	84"	96"	60"	108"	N/A	N/A	96"	12"	96"	36"	N/A
Kato	144"	120"	96"	96"	108"	84"	96"	N/A	N/A	N/A	N/A	96"	12"	96"	36"	72"
Kazuki	144"	120"	96"	96"	108"	84"	96"	60"	108"	60"	30"	96"	12"	96"	36"	72"
Khan	144"	120"	N/A	96"	108"	84"	96"	60"	108"	60"	30"	N/A	N/A	N/A	N/A	72"
Kwan	144"	120"	96"	96"	108"	84"	96"	60"	108"	60"	30"	96"	12"	96"	36"	72"
Lada	144"	120"	N/A	96"	108"	84"	96"	60"	108"	60"	30"	N/A	N/A	96"	36"	72"
Lani	144"	120"	96"	96"	108"	84"	96"	60"	108"	60"	30"	96"	12"	96"	36"	72"
Lea	144"	120"	96"	96"	108"	84"	96"	60"	108"	60"	30"	118"	12"	96"	36"	72"
Maka	144"	120"	96"	96"	108"	84"	96"	60"	108"	60"	30"	96"	12"	96"	36"	72"
Malana	144"	120"	96"	96"	108"	84"	96"	60"	108"	60"	30"	96"	12"	96"	36"	N/A
Malie	144"	120"	96"	96"	108"	84"	96"	60"	108"	N/A	N/A	96"	12"	96"	36"	N/A
Miya	144"	120"	96"	96"	108"	84"	96"	60"	108"	60"	30"	118"	12"	96"	36"	72"
Naoki	144"	120"	96"	96"	108"	84"	96"	60"	108"	60"	30"	118"	12"	96"	36"	72"
Okalani	144"	120"	96"	96"	108"	84"	96"	60"	108"	60"	30"	118"	12"	96"	36"	N/A
Osaka	144"	120"	96"	96"	108"	84"	96"	60"	108"	60"	30"	96"	12"	96"	36"	72"
Sapporo	144"	120"	96"	96"	108"	84"	96"	N/A	N/A	N/A	N/A	96"	12"	96"	36"	N/A
Sasarido	144"	120"	96"	96"	108"	84"	96"	N/A	N/A	N/A	N/A	96"	12"	96"	36"	72"
Sibu	144"	120"	N/A	96"	108"	96"	96"	60"	108"	60"	30"	N/A	N/A	96"	36"	72"
Srilanka	144"	120"	96"	96"	108"	84"	96"	N/A	N/A	N/A	N/A	96"	12"	96"	36"	72"
Taipei	144"	120"	96"	96"	108"	84"	96"	N/A	N/A	N/A	N/A	96"	12"	96"	36"	72"
Taishan	144"	120"	N/A	96"	108"	84"	96"	60"	108"	60"	30"	N/A	N/A	96"	36"	72"
Tomiko	144"	120"	96"	96"	108"	84"	96"	60"	108"	60"	30"	96"	12"	96"	36"	72"
Ulani	144"	120"	96"	96"	108"	84"	96"	60"	108"	60"	30"	96"	12"	96"	36"	72"
Waja	144"	120"	96"	96"	108"	84"	96"	60"	108"	60"	30"	118"	12"	96"	36"	72"
Zhen	144"	120"	N/A	96"	108"	84"	96"	N/A	N/A	N/A	N/A	N/A	N/A	96"	36"	72"
Minimum:	45"	30"	30"	24"	30"	15"	30"	15"	30"	12"	6"	15"	12"	15"	12"	15"

CareRING Cordless System Specifications

Manh Truc Flat Roman with CareRING Cordless - Unlined

- See page 4 for CareRING Cordless Size Chart to be used for each pattern.
- Minimum width for most CareRING Charts is 18 1/2" (exception Chart 4 with heaviest fabrics).

CF1 CareRING Cordless MAX SIZE		FLAT ROMAN UNLINED											
WIDTH:		18 1/2"	26 7/16"	26 1/2"	30"	36"	42"	48"	54"	60"	66"	72"	78"
HEIGHT TO:	24"	✓	✓	✓	✓	✓	✓	✓	✓	✓	✓	✓	✓
	30"	✓	✓	✓	✓	✓	✓	✓	✓	✓	✓	✓	✓
	36"	✓	✓	✓	✓	✓	✓	✓	✓	✓	✓	✓	✓
	42"	✓	✓	✓	✓	✓	✓	✓	✓	✓	✓	✓	✓
	48"	✓	No	✓	✓	✓	✓	✓	✓	✓	✓	✓	✓
	54"	✓	No	✓	✓	✓	✓	✓	✓	✓	✓	✓	✓
	60"	No	No	✓	✓	✓	✓	✓	✓	✓	✓	✓	No
	66"	No	No	✓	✓	✓	✓	✓	✓	✓	✓	✓	No
	72"	No	No	✓	✓	✓	✓	✓	✓	✓	✓	✓	No
	78"	No	No	✓	✓	✓	✓	✓	✓	✓	✓	✓	No
84"	No	No	✓	✓	✓	✓	✓	✓	✓	✓	No	No	

CF3 CareRING Cordless MAX SIZE		FLAT ROMAN UNLINED											
WIDTH:		18 1/2"	26 7/16"	26 1/2"	30"	36"	42"	48"	54"	60"	66"	72"	78"
HEIGHT TO:	24"	✓	✓	✓	✓	✓	✓	✓	✓	✓	✓	✓	✓
	30"	✓	✓	✓	✓	✓	✓	✓	✓	✓	✓	✓	✓
	36"	✓	No	✓	✓	✓	✓	✓	✓	✓	✓	✓	✓
	42"	✓	No	✓	✓	✓	✓	✓	✓	✓	✓	✓	✓
	48"	✓	No	✓	✓	✓	✓	✓	✓	✓	✓	✓	✓
	54"	No	No	✓	✓	✓	✓	✓	✓	✓	✓	✓	✓
	60"	No	No	✓	✓	✓	✓	✓	✓	✓	✓	✓	No
	66"	No	No	✓	✓	✓	✓	✓	✓	✓	✓	No	No
	72"	No	No	✓	✓	✓	✓	✓	✓	✓	No	No	No
	78"	No	No	✓	✓	✓	✓	✓	✓	No	No	No	No
84"	No	No	✓	✓	✓	✓	✓	✓	✓	No	No	No	

CF2 CareRING Cordless MAX SIZE		FLAT ROMAN UNLINED											
WIDTH:		18 1/2"	26 7/16"	26 1/2"	30"	36"	42"	48"	54"	60"	66"	72"	78"
HEIGHT TO:	24"	✓	✓	✓	✓	✓	✓	✓	✓	✓	✓	✓	✓
	30"	✓	✓	✓	✓	✓	✓	✓	✓	✓	✓	✓	✓
	36"	✓	No	✓	✓	✓	✓	✓	✓	✓	✓	✓	✓
	42"	✓	No	✓	✓	✓	✓	✓	✓	✓	✓	✓	✓
	48"	✓	No	✓	✓	✓	✓	✓	✓	✓	✓	✓	✓
	54"	No	No	✓	✓	✓	✓	✓	✓	✓	✓	✓	✓
	60"	No	No	✓	✓	✓	✓	✓	✓	✓	✓	✓	No
	66"	No	No	✓	✓	✓	✓	✓	✓	✓	✓	✓	No
	72"	No	No	✓	✓	✓	✓	✓	✓	✓	No	No	No
	78"	No	No	✓	✓	✓	✓	✓	✓	No	No	No	No
84"	No	No	✓	✓	✓	✓	✓	✓	No	No	No	No	

CF4 CareRING Cordless MAX SIZE		FLAT ROMAN UNLINED										
WIDTH:		26 1/2"	30"	36"	42"	48"	54"	60"	66"	72"	78"	
HEIGHT TO:	24"	✓	✓	✓	✓	✓	✓	✓	✓	✓	✓	
	30"	✓	✓	✓	✓	✓	✓	✓	✓	✓	✓	
	36"	✓	✓	✓	✓	✓	✓	✓	No	No	No	
	42"	No	✓	✓	✓	✓	✓	No	No	No	No	
	48"	No	✓	✓	✓	No	No	No	No	No	No	
	54"	No	No	✓	✓	No	No	No	No	No	No	
	60"	No	No	✓	✓	No	No	No	No	No	No	
	66"	No	No	✓	No	No	No	No	No	No	No	
	72"	No	No	✓	No	No	No	No	No	No	No	
	78"	No	No	No	No	No	No	No	No	No	No	
84"	No	No	No	No	No	No	No	No	No	No		

Manh Truc Flat Roman with CareRING Cordless - Light Filtering (LF) Lining

LF1 CareRING Cordless MAX SIZE		FLAT ROMAN LIGHT FILTERING LINING											
WIDTH:		18 1/2"	26 7/16"	26 1/2"	30"	36"	42"	48"	54"	60"	66"	72"	78"
HEIGHT TO:	24"	✓	✓	✓	✓	✓	✓	✓	✓	✓	✓	✓	✓
	30"	✓	✓	✓	✓	✓	✓	✓	✓	✓	✓	✓	✓
	36"	✓	No	✓	✓	✓	✓	✓	✓	✓	✓	✓	✓
	42"	✓	No	✓	✓	✓	✓	✓	✓	✓	✓	✓	✓
	48"	✓	No	✓	✓	✓	✓	✓	✓	✓	✓	✓	✓
	54"	No	No	✓	✓	✓	✓	✓	✓	✓	✓	✓	✓
	60"	No	No	✓	✓	✓	✓	✓	✓	✓	✓	✓	No
	66"	No	No	✓	✓	✓	✓	✓	✓	✓	✓	✓	No
	72"	No	No	✓	✓	✓	✓	✓	✓	✓	✓	✓	No
	78"	No	No	✓	✓	✓	✓	✓	✓	✓	✓	No	No
84"	No	No	No	✓	✓	✓	✓	✓	✓	No	No	No	

LF3 CareRING Cordless MAX SIZE		FLAT ROMAN LIGHT FILTERING LINING											
WIDTH:		18 1/2"	26 7/16"	26 1/2"	30"	36"	42"	48"	54"	60"	66"	72"	78"
HEIGHT TO:	24"	✓	✓	✓	✓	✓	✓	✓	✓	✓	✓	✓	✓
	30"	✓	No	✓	✓	✓	✓	✓	✓	✓	✓	✓	✓
	36"	✓	No	✓	✓	✓	✓	✓	✓	✓	✓	✓	✓
	42"	✓	No	✓	✓	✓	✓	✓	✓	✓	✓	✓	✓
	48"	No	No	✓	✓	✓	✓	✓	✓	✓	✓	✓	✓
	54"	No	No	✓	✓	✓	✓	✓	✓	✓	✓	✓	✓
	60"	No	No	✓	✓	✓	✓	✓	✓	✓	✓	No	No
	66"	No	No	✓	✓	✓	✓	✓	✓	✓	No	No	No
	72"	No	No	No	✓	✓	✓	✓	✓	No	No	No	No
	78"	No	No	No	✓	✓	✓	✓	No	No	No	No	No
84"	No	No	No	✓	✓	✓	✓	No	No	No	No	No	

LF2 CareRING Cordless MAX SIZE		FLAT ROMAN LIGHT FILTERING LINING											
WIDTH:		18 1/2"	26 7/16"	26 1/2"	30"	36"	42"	48"	54"	60"	66"	72"	78"
HEIGHT TO:	24"	✓	✓	✓	✓	✓	✓	✓	✓	✓	✓	✓	✓
	30"	✓	✓	✓	✓	✓	✓	✓	✓	✓	✓	✓	✓
	36"	✓	No	✓	✓	✓	✓	✓	✓	✓	✓	✓	✓
	42"	✓	No	✓	✓	✓	✓	✓	✓	✓	✓	✓	✓
	48"	✓	No	✓	✓	✓	✓	✓	✓	✓	✓	✓	✓
	54"	No	No	✓	✓	✓	✓	✓	✓	✓	✓	✓	✓
	60"	No	No	✓	✓	✓	✓	✓	✓	✓	✓	✓	No
	66"	No	No	✓	✓	✓	✓	✓	✓	✓	✓	No	No
	72"	No	No	✓	✓	✓	✓	✓	✓	✓	No	No	No
	78"	No	No	✓	✓	✓	✓	✓	✓	No	No	No	No
84"	No	No	✓	✓	✓	✓	✓	No	No	No	No	No	

LF4 CareRING Cordless MAX SIZE		FLAT ROMAN LIGHT FILTERING LINING										
WIDTH:		26 1/2"	30"	36"	42"	48"	54"	60"	66"	72"	78"	
HEIGHT TO:	24"	✓	✓	✓	✓	✓	✓	✓	✓	✓	✓	
	30"	✓	✓	✓	✓	✓	✓	✓	✓	✓	No	
	36"	No	✓	✓	✓	✓	✓	✓	No	No	No	
	42"	No	✓	✓	✓	✓	✓	No	No	No	No	
	48"	No	No	✓	✓	✓	No	No	No	No	No	
	54"	No	No	✓	✓	No	No	No	No	No	No	
	60"	No	No	✓	No	No	No	No	No	No	No	
	66"	No	No	No	No	No	No	No	No	No	No	
	72"	No	No	No	No	No	No	No	No	No	No	
	78"	No	No	No	No	No	No	No	No	No	No	
84"	No	No	No	No	No	No	No	No	No	No		

CareRING Cordless System Specifications

Manh Truc Flat Roman with CareRING Cordless - Opaque (OP) Lining

OP1 CareRING Cordless MAX SIZE		FLAT ROMAN OPAQUE LINING											
WIDTH:		18 1/2"	26 7/16"	26 1/2"	30"	36"	42"	48"	54"	60"	66"	72"	78"
HEIGHT TO:	24"	✓	✓	✓	✓	✓	✓	✓	✓	✓	✓	✓	✓
	30"	✓	✓	✓	✓	✓	✓	✓	✓	✓	✓	✓	✓
	36"	✓	No	✓	✓	✓	✓	✓	✓	✓	✓	✓	✓
	42"	✓	No	✓	✓	✓	✓	✓	✓	✓	✓	✓	✓
	48"	✓	No	✓	✓	✓	✓	✓	✓	✓	✓	✓	✓
	54"	No	No	✓	✓	✓	✓	✓	✓	✓	✓	✓	✓
	60"	No	No	✓	✓	✓	✓	✓	✓	✓	✓	✓	No
	66"	No	No	✓	✓	✓	✓	✓	✓	✓	✓	✓	No
	72"	No	No	✓	✓	✓	✓	✓	✓	✓	✓	No	No
	78"	No	No	No	✓	✓	✓	✓	✓	✓	No	No	No
84"	No	No	No	✓	✓	✓	✓	✓	No	No	No	No	

OP3 CareRING Cordless MAX SIZE		FLAT ROMAN OPAQUE LINING											
WIDTH:		18 1/2"	26 7/16"	26 1/2"	30"	36"	42"	48"	54"	60"	66"	72"	78"
HEIGHT TO:	24"	✓	✓	✓	✓	✓	✓	✓	✓	✓	✓	✓	✓
	30"	✓	No	✓	✓	✓	✓	✓	✓	✓	✓	✓	✓
	36"	✓	No	✓	✓	✓	✓	✓	✓	✓	✓	✓	✓
	42"	✓	No	✓	✓	✓	✓	✓	✓	✓	✓	✓	✓
	48"	No	No	✓	✓	✓	✓	✓	✓	✓	✓	✓	✓
	54"	No	No	✓	✓	✓	✓	✓	✓	✓	✓	✓	No
	60"	No	No	✓	✓	✓	✓	✓	✓	✓	No	No	No
	66"	No	No	No	✓	✓	✓	✓	✓	No	No	No	No
	72"	No	No	No	✓	✓	✓	✓	No	No	No	No	No
	78"	No	No	No	✓	✓	✓	✓	No	No	No	No	No
84"	No	No	No	✓	✓	✓	No	No	No	No	No	No	

OP2 CareRING Cordless MAX SIZE		FLAT ROMAN OPAQUE LINING											
WIDTH:		18 1/2"	26 7/16"	26 1/2"	30"	36"	42"	48"	54"	60"	66"	72"	78"
HEIGHT TO:	24"	✓	✓	✓	✓	✓	✓	✓	✓	✓	✓	✓	✓
	30"	✓	No	✓	✓	✓	✓	✓	✓	✓	✓	✓	✓
	36"	✓	No	✓	✓	✓	✓	✓	✓	✓	✓	✓	✓
	42"	✓	No	✓	✓	✓	✓	✓	✓	✓	✓	✓	✓
	48"	No	No	✓	✓	✓	✓	✓	✓	✓	✓	✓	✓
	54"	No	No	✓	✓	✓	✓	✓	✓	✓	✓	✓	✓
	60"	No	No	✓	✓	✓	✓	✓	✓	✓	No	No	No
	66"	No	No	✓	✓	✓	✓	✓	✓	No	No	No	No
	72"	No	No	✓	✓	✓	✓	✓	No	No	No	No	No
	78"	No	No	✓	✓	✓	✓	No	No	No	No	No	No
84"	No	No	✓	✓	✓	✓	No	No	No	No	No	No	

OP4 CareRING Cordless MAX SIZE		FLAT ROMAN OPAQUE LINING											
WIDTH:		26 1/2"	30"	36"	42"	48"	54"	60"	66"	72"	78"		
HEIGHT TO:	24"	✓	✓	✓	✓	✓	✓	✓	✓	✓	✓		
	30"	✓	✓	✓	✓	✓	✓	✓	No	No	No		
	36"	No	✓	✓	✓	✓	✓	No	No	No	No		
	42"	No	✓	✓	✓	✓	No	No	No	No	No		
	48"	No	No	✓	✓	No	No	No	No	No	No		
	54"	No	No	✓	No	No	No	No	No	No	No		
	60"	No	No	✓	No	No	No	No	No	No	No		
	66"	No	No	No	No	No	No	No	No	No	No		
	72"	No	No	No	No	No	No	No	No	No	No		
	78"	No	No	No	No	No	No	No	No	No	No		
84"	No	No	No	No	No	No	No	No	No	No			

Manh Truc Hobbled Roman with CareRING Cordless - Unlined Only

CH1 CareRING Cordless MAX SIZE		HOBBLED ROMAN UNLINED											
WIDTH:		18 1/2"	26 7/16"	26 1/2"	30"	36"	42"	48"	54"	60"	66"	72"	78"
HEIGHT TO:	24"	No	No	✓	✓	✓	✓	✓	✓	✓	✓	✓	✓
	30"	No	No	✓	✓	✓	✓	✓	✓	✓	✓	✓	✓
	36"	No	No	✓	✓	✓	✓	✓	✓	✓	No	No	No
	42"	No	No	No	✓	✓	✓	✓	✓	No	No	No	No
	48"	No	No	No	✓	✓	✓	✓	No	No	No	No	No
	54"	No	No	No	No	✓	✓	No	No	No	No	No	No
	60"	No	No	No	No	✓	No	No	No	No	No	No	No
	66"	No	No	No	No	✓	No	No	No	No	No	No	No
	72"	No	No	No	No	✓	No	No	No	No	No	No	No
	78"	No	No	No	No	No	No	No	No	No	No	No	No
84"	No	No	No	No	No	No	No	No	No	No	No	No	

CH3 CareRING Cordless MAX SIZE		HOBBLED ROMAN UNLINED											
WIDTH:		18 1/2"	26 7/16"	26 1/2"	30"	36"	42"	48"	54"	60"	66"	72"	78"
HEIGHT TO:	24"	No	No	✓	✓	✓	✓	✓	✓	✓	✓	✓	✓
	30"	No	No	✓	✓	✓	✓	✓	✓	✓	✓	No	No
	36"	No	No	No	✓	✓	✓	✓	✓	No	No	No	No
	42"	No	No	No	✓	✓	✓	✓	No	No	No	No	No
	48"	No	No	No	No	✓	✓	No	No	No	No	No	No
	54"	No	No	No	No	✓	No	No	No	No	No	No	No
	60"	No	No	No	No	✓	No	No	No	No	No	No	No
	66"	No	No	No	No	No	No	No	No	No	No	No	No
	72"	No	No	No	No	No	No	No	No	No	No	No	No
	78"	No	No	No	No	No	No	No	No	No	No	No	No
84"	No	No	No	No	No	No	No	No	No	No	No	No	

CH2 CareRING Cordless MAX SIZE		HOBBLED ROMAN UNLINED											
WIDTH:		18 1/2"	26 7/16"	26 1/2"	30"	36"	42"	48"	54"	60"	66"	72"	78"
HEIGHT TO:	24"	No	No	✓	✓	✓	✓	✓	✓	✓	✓	✓	✓
	30"	No	No	✓	✓	✓	✓	✓	✓	✓	✓	✓	No
	36"	No	No	No	✓	✓	✓	✓	✓	No	No	No	No
	42"	No	No	No	✓	✓	✓	✓	No	No	No	No	No
	48"	No	No	No	No	✓	✓	✓	No	No	No	No	No
	54"	No	No	No	No	✓	No	No	No	No	No	No	No
	60"	No	No	No	No	✓	No	No	No	No	No	No	No
	66"	No	No	No	No	No	No	No	No	No	No	No	No
	72"	No	No	No	No	No	No	No	No	No	No	No	No
	78"	No	No	No	No	No	No	No	No	No	No	No	No
84"	No	No	No	No	No	No	No	No	No	No	No	No	

CH4 CareRING Cordless MAX SIZE		HOBBLED ROMAN UNLINED											
WIDTH:		26 1/2"	30"	36"	42"	48"	54"	60"	66"	72"	78"		
HEIGHT TO:	24"	✓	✓	✓	✓	✓	✓	✓	✓	✓	✓		
	30"	No	✓	✓	✓	✓	✓	✓	No	No	No		
	36"	No	✓	✓	✓	✓	✓	No	No	No	No		
	42"	No	No	✓	✓	No	No	No	No	No	No		
	48"	No	No	✓	No	No	No	No	No	No	No		
	54"	No	No	✓	No	No	No	No	No	No	No		
	60"	No	No	No	No	No	No	No	No	No	No		
	66"	No	No	No	No	No	No	No	No	No	No		
	72"	No	No	No	No	No	No	No	No	No	No		
	78"	No	No	No	No	No	No	No	No	No	No		
84"	No	No	No	No	No	No	No	No	No	No			

Specification Summary

Manh Truc Flat Roman Shades - Motorized

	System II Maximum Width / Length	System II Max Sq Ft. Flat Unlined	System II Max Sq Ft. Flat Lined LF	System II Max Sq Ft. Flat Lined Opaque	Sonesse 30 WF Maximum Width / Length	Sonesse 30 WF Max Sq Ft. Flat Unlined	Sonesse 30 WF Max Sq Ft. Lined LF	Sonesse 30 WF Max Sq Ft. Lined Opaque
Akela	96" / 96"	50	45	40	96" / 96"	64	60	55
Aris	96" / 96"	45	40	35	96" / 96"	60	55	50
Bacopa	96" / 96"	35	30	25	96" / 96"	50	45	40
Batang	96" / 96"	45	40	35	96" / 96"	55	50	45
Bayani	96" / 96"	50	45	40	96" / 96"	64	60	55
Beijing	95" / 96"	50	45	40	96" / 96"	64	60	55
Bengali	96" / 96"	50	45	40	96" / 96"	64	60	55
Caracas	N/A	N/A	N/A	N/A	N/A	N/A	N/A	N/A
Chakra	96" / 96"	50	45	40	96" / 96"	64	60	55
Chinda	96" / 96"	50	45	40	96" / 96"	64	60	55
Dieu	96" / 96"	50	45	40	96" / 96"	64	60	55
Dynasty	96" / 96"	40	35	30	96" / 96"	55	45	40
Hanoi	94" / 96"	50	45	40	94" / 96"	64	60	55
Jambu	96" / 96"	45	40	35	96" / 96"	55	50	45
Jilin	96" / 96"	40	35	30	96" / 96"	50	45	40
Kaila	72" / 96"	50	45	40	72" / 96"	64	60	55
Kaliko	96" / 96"	50	45	40	96" / 96"	64	60	55
Kato	96" / 96"	50	45	40	96" / 96"	64	60	55
Kazuki	96" / 96"	50	45	40	96" / 96"	64	60	55
Khan	96" / 96"	50	45	40	96" / 96"	64	60	55
Kwan	96" / 96"	50	45	40	96" / 96"	64	60	55
Lada	96" / 96"	50	45	40	96" / 96"	64	60	55
Lani	96" / 96"	50	45	40	96" / 96"	64	60	55
Lea	96" / 96"	50	45	40	96" / 96"	64	60	55
Maka	96" / 96"	50	45	40	96" / 96"	64	60	55
Malana	96" / 96"	50	45	40	96" / 96"	64	60	55
Malie	96" / 96"	50	45	40	96" / 96"	64	60	55
Miya	96" / 96"	50	45	40	96" / 96"	64	60	55
Naoki	96" / 96"	45	40	35	96" / 96"	55	50	45
Okalani	96" / 96"	50	45	40	96" / 96"	64	60	55
Osaka	96" / 96"	50	45	40	96" / 96"	64	60	55
Sapporo	96" / 96"	40	35	30	96" / 96"	50	45	40
Sasarido	96" / 96"	50	45	40	96" / 96"	64	60	55
Sibu	96" / 96"	50	45	40	96" / 96"	64	60	55
Srilanka	96" / 96"	50	45	40	96" / 96"	64	60	55
Taipei	96" / 96"	35	30	25	96" / 96"	50	45	40
Taishan	96" / 96"	50	45	40	96" / 96"	64	60	55
Tomiko	96" / 96"	35	30	25	96" / 96"	50	45	40
Ulani	96" / 96"	50	45	40	96" / 96"	64	60	55
Waja	96" / 96"	50	45	40	96" / 96"	64	60	55
Zhen	96" / 96"	45	40	35	96" / 96"	55	50	45
Minimum:	16" / 24"				30" / 24"			

Specification Summary

Manh Truc Flat Roman Shades - Motorized

	EZ Charge 2.0 Maximum Width / Length	EZ Charge 2.0 Max Sq Ft. Flat Unlined	EZ Charge 2.0 Max Sq Ft. Flat Lined LF	EZ Charge 2.0 Max Sq Ft. Flat Lined Opaque	EZ Charge X2 Maximum Width / Length	EZ Charge X2 Max Sq Ft. Flat Unlined	EZ Charge X2 Max Sq Ft. Lined LF	EZ Charge X2 Max Sq Ft. Lined Opaque
Akela	96" / 96"	50	45	40	96" / 96"	64	60	55
Aris	96" / 96"	45	40	35	96" / 96"	60	55	50
Bacopa	96" / 96"	35	30	25	96" / 96"	50	45	40
Batang	96" / 96"	45	40	35	96" / 96"	55	50	45
Bayani	96" / 96"	50	45	40	96" / 96"	64	60	55
Beijing	95" / 96"	50	45	40	96" / 96"	64	60	55
Bengali	96" / 96"	50	45	40	96" / 96"	64	60	55
Caracas	N/A	N/A	N/A	N/A	N/A	N/A	N/A	N/A
Chakra	96" / 96"	50	45	40	96" / 96"	64	60	55
Chinda	96" / 96"	50	45	40	96" / 96"	64	60	55
Dieu	96" / 96"	50	45	40	96" / 96"	64	60	55
Dynasty	96" / 96"	40	35	30	96" / 96"	55	50	45
Hanoi	94" / 96"	50	45	40	94" / 96"	64	60	55
Jambu	96" / 96"	45	40	35	96" / 96"	55	50	45
Jilin	96" / 96"	40	35	30	96" / 96"	50	45	40
Kaila	72" / 96"	50	45	40	72" / 96"	64	60	55
Kaliko	96" / 96"	50	45	40	96" / 96"	64	60	55
Kato	96" / 96"	50	45	40	96" / 96"	64	60	55
Kazuki	96" / 96"	50	45	40	96" / 96"	64	60	55
Khan	96" / 96"	50	45	40	96" / 96"	64	60	55
Kwan	96" / 96"	50	45	40	96" / 96"	64	60	55
Lada	96" / 96"	50	45	40	96" / 96"	64	60	55
Lani	96" / 96"	50	45	40	96" / 96"	64	60	55
Lea	96" / 96"	50	45	40	96" / 96"	64	60	55
Maka	96" / 96"	50	45	40	96" / 96"	64	60	55
Malana	96" / 96"	50	45	40	96" / 96"	64	60	55
Malie	96" / 96"	50	45	40	96" / 96"	64	60	55
Miya	96" / 96"	50	45	40	96" / 96"	64	60	55
Naoki	96" / 96"	45	40	35	96" / 96"	55	50	45
Okalani	96" / 96"	50	45	40	96" / 96"	64	60	55
Osaka	96" / 96"	50	45	40	96" / 96"	64	60	55
Sapporo	96" / 96"	40	35	30	96" / 96"	50	45	40
Sasarido	96" / 96"	50	45	40	96" / 96"	64	60	55
Sibu	96" / 96"	50	45	40	96" / 96"	64	60	55
Srilanka	96" / 96"	50	45	40	96" / 96"	64	60	55
Taipei	96" / 96"	35	30	25	96" / 96"	50	45	40
Taishan	96" / 96"	50	45	40	96" / 96"	64	60	55
Tomiko	96" / 96"	35	30	25	96" / 96"	50	45	40
Ulani	96" / 96"	50	45	40	96" / 96"	64	60	55
Waja	96" / 96"	50	45	40	96" / 96"	64	60	55
Zhen	96" / 96"	45	40	35	96" / 96"	55	50	45
Minimum:	22" / 24"				30" / 24"			

Specification Summary

Manh Truc Flat Roman Shades - Motorized

	EZ Charge X3 Maximum Width / Length	EZ Charge X3 Max Sq Ft. Flat Unlined	EZ Charge X3 Max Sq Ft. Flat Lined LF	EZ Charge X3 Max Sq Ft. Flat Lined Opaque	Auto-Wand Maximum Width / Length	Auto-Wand Max Sq Ft. Flat Unlined	Auto-Wand Max Sq Ft. Lined LF	Auto-Wand Max Sq Ft. Lined Opaque
Akela	96" / 96"	64	64	64	96" / 96"	50	45	40
Aris	96" / 96"	64	64	64	96" / 96"	45	40	35
Bacopa	96" / 96"	64	64	64	96" / 96"	35	30	25
Batang	96" / 96"	64	64	64	96" / 96"	45	40	35
Bayani	96" / 96"	64	64	64	96" / 96"	50	45	40
Beijing	95" / 96"	64	64	64	95" / 96"	50	45	40
Bengali	96" / 96"	64	64	64	96" / 96"	50	45	40
Caracas	N/A	N/A	N/A	N/A	N/A	N/A	N/A	N/A
Chakra	96" / 96"	64	64	64	96" / 96"	50	45	40
Chinda	96" / 96"	64	64	64	96" / 96"	50	45	40
Dieu	96" / 96"	64	64	64	96" / 96"	50	45	40
Dynasty	96" / 96"	64	64	64	96" / 96"	40	35	30
Hanoi	94" / 96"	64	64	64	94" / 96"	50	45	40
Jambu	96" / 96"	64	64	64	96" / 96"	45	40	35
Jilin	96" / 96"	64	64	64	96" / 96"	40	35	30
Kaila	72" / 96"	64	64	64	72" / 96"	50	45	40
Kaliko	96" / 96"	64	64	64	96" / 96"	50	45	40
Kato	96" / 96"	64	64	64	96" / 96"	50	45	40
Kazuki	96" / 96"	64	64	64	96" / 96"	50	45	40
Khan	96" / 96"	64	64	64	96" / 96"	50	45	40
Kwan	96" / 96"	64	64	64	96" / 96"	50	45	40
Lada	96" / 96"	64	64	64	96" / 96"	50	45	40
Lani	96" / 96"	64	64	64	96" / 96"	50	45	40
Lea	96" / 96"	64	64	64	96" / 96"	50	45	40
Maka	96" / 96"	64	64	64	96" / 96"	50	45	40
Malana	96" / 96"	64	64	64	96" / 96"	50	45	40
Malie	96" / 96"	64	64	64	96" / 96"	50	45	40
Miya	96" / 96"	64	64	64	96" / 96"	50	45	40
Naoki	96" / 96"	64	64	64	96" / 96"	45	40	35
Okalani	96" / 96"	64	64	64	96" / 96"	50	45	40
Osaka	96" / 96"	64	64	64	96" / 96"	50	45	40
Sapporo	96" / 96"	64	64	64	96" / 96"	40	35	30
Sasarido	96" / 96"	64	64	64	96" / 96"	50	45	40
Sibu	96" / 96"	64	64	64	96" / 96"	50	45	40
Srilanka	96" / 96"	64	64	64	96" / 96"	50	45	40
Taipei	96" / 96"	64	64	64	96" / 96"	35	30	25
Taishan	96" / 96"	64	64	64	96" / 96"	50	45	40
Tomiko	96" / 96"	64	64	64	96" / 96"	35	30	25
Ulani	96" / 96"	64	64	64	96" / 96"	50	45	40
Waja	96" / 96"	64	64	64	96" / 96"	50	45	40
Zhen	96" / 96"	64	64	64	96" / 96"	45	40	35
Minimums	42" / 24"				22" / 28"			

Specification Summary

Manh Truc Roller Shades, Panel Track, Panel Drape, Grommet Panel

Maximum Sizes	Roller Shade		Panel Track		Panel Drape		Stationary Grommet Panel	Manh Truc Shutters
	Width	Length	Width	Length *	Width	Length	Length	
Akela	N/A	N/A	N/A	N/A	120"	118"***	94"***	N/A
Aris	N/A	N/A	144"	108"/96"	120"	118"	94"	✓
Bacopa	N/A	N/A	N/A	N/A	N/A	N/A	N/A	✓
Batang	N/A	N/A	N/A	N/A	120"	94"	94"	✓
Bayani	84"	84"	144"	108"/96"	120"	94"	94"	✓
Beijing	N/A	N/A	N/A	N/A	120"	118"***	94"***	N/A
Bengali	N/A	N/A	144"	108"/96"	120"	94"***	94"***	✓
Caracas	N/A	N/A	N/A	N/A	N/A	N/A	N/A	✓
Chakra	N/A	N/A	N/A	N/A	N/A	N/A	N/A	N/A
Chinda	84"	84"	N/A	N/A	120"	118"***	94"***	N/A
Dieu	84"	84"	N/A	N/A	120"	94"	94"	✓
Dynasty	84"	84"	144"	108"/96"	120"	118"	94"	✓
Hanoi	N/A	N/A	144"	108"/96"	120"	94"	94"	✓
Jambu	84"	84"	144"	108"/96"	120"	118"	94"	✓
Jilin	N/A	N/A	144"	108"/96"	120"	118"	94"	✓
Kaila	72"	84"	N/A	N/A	120"	70"***	70"***	✓
Kaliko	N/A	N/A	N/A	N/A	120"	94"***	94"***	N/A
Kato	N/A	N/A	N/A	N/A	120"	94"	94"	N/A
Kazuki	84"	84"	144"	108"/96"	120"	94"	94"	✓
Khan	N/A	N/A	N/A	N/A	N/A	N/A	N/A	✓
Kwan	N/A	N/A	N/A	N/A	120"	94"***	94"***	N/A
Lada	N/A	N/A	N/A	N/A	N/A	N/A	N/A	✓
Lani	N/A	N/A	N/A	N/A	120"	94"***	94"***	✓
Lea	N/A	N/A	N/A	N/A	120"	118"***	94"***	N/A
Maka	N/A	N/A	N/A	N/A	120"	94"	94"	✓
Malana	N/A	N/A	N/A	N/A	120"	94"***	94"***	N/A
Malie	N/A	N/A	N/A	N/A	120"	94"***	94"***	N/A
Miya	84"	84"	144"	108"/96"	120"	118"***	94"***	✓
Naoki	84"	84"	N/A	N/A	N/A	N/A	N/A	✓
Okalani	N/A	N/A	N/A	N/A	120"	118"	94"	N/A
Osaka	84"	84"	144"	108"/96"	120"	94"	94"	✓
Sapporo	N/A	N/A	N/A	N/A	N/A	N/A	N/A	✓
Sasarido	84"	84"	N/A	N/A	120"	94"	94"	N/A
Sibu	N/A	N/A	N/A	N/A	N/A	N/A	N/A	✓
Srilanka	N/A	N/A	N/A	N/A	N/A	N/A	N/A	N/A
Taipei	N/A	N/A	N/A	N/A	N/A	N/A	N/A	N/A
Taishan	N/A	N/A	N/A	N/A	120"	94"	94"	✓
Tomiko	N/A	N/A	144"	108"/96"	120"	94"	94"	✓
Ulani	84"	84"	144"	108"/96"	120"	94"	94"	✓
Waja	84"	84"	144"	108"/96"	120"	118"	94"	✓
Zhen	N/A	N/A	N/A	N/A	N/A	N/A	N/A	N/A
Minimum:	24"	30"	27"	24"/39"	36"	24"	24"	See Shutter PL

* Panel Track has 108" Cord Draw Max. Length and 96" Wand Draw Max. Length / 24" Cord Draw Min. Length and 39" Wand Draw Min. Length

** Cannot have Bottom Banding due to flaring

Specification Summary

Manh Truc Roman Shades - Options Cross Reference

Roman Shades Options Availability	Flat Roman	Hobbled Roman	CareRING Cordless	Top Down Bottom Up	Duo Shade	Angle Top	Arch Top	Arch or Framed Arch	Flat Roman Motorized	Notes
No Charge Options										
Bead Chain Length Override	✓	✓	⊘	⊘	⊘	⊘	⊘	⊘	⊘	
Clutch System - Quick Lift	✓	✓	⊘	⊘	⊘	⊘	⊘	⊘	⊘	N/A with NY Bracket
Clutch System - Traditional Lift	✓	✓	⊘	⊘	⊘	⊘	⊘	⊘	⊘	
Cord Length Override	✓	✓	⊘	✓	✓	✓	✓	⊘	⊘	
Cord Lock System - Contemporary	✓	✓	⊘	⊘	✓	⊘	✓	⊘	⊘	
Cord Lock System - Traditional	✓	✓	⊘	✓	✓	✓	✓	⊘	⊘	
Hold Downs	✓	✓	✓	✓	✓	✓	✓	⊘	✓	
New York Brackets	✓	✓	⊘	✓	✓	⊘	⊘	⊘	⊘	
Soft Returns	✓	✓	✓	✓	✓	⊘	⊘	⊘	✓	Std on spec pg
Turned Headrail	✓	✓	⊘	⊘	✓	⊘	⊘	⊘	⊘	
Surcharge Options										
Coating - Antimicrobial	✓	✓	✓	✓	✓	✓	✓	✓	✓	
Coating - Flame Retardant	✓	✓	✓	✓	✓	✓	✓	✓	✓	
Edge Banding	✓	✓	⊘	✓	✓	✓	VBH2 only	⊘	✓	
Lining - Shade or Valance	✓	⊘	Flat Only	With Banding	⊘	✓	✓	✓	✓	
Multiple Blinds on One Headrail	✓	✓	⊘	⊘	⊘	⊘	⊘	⊘	✓	
Straight Trim	✓	✓	✓	✓	✓	✓	⊘	⊘	✓	
Valance Height - Addtl 12"	✓	✓	✓	✓	✓	✓	✓	⊘	✓	
Wood Bottom Hem	✓	✓	⊘	✓	⊘	✓	✓	⊘	✓	
Notes:			N/A TDBU	N/A CareRING						

Valance and Cornice Options	Shade Self Valance	Hobbled Cornice	Waterfall Valance	Railroaded Cornice	Straight Cornice	Majesty or Camelot Valance
Order separately	⊘	✓	✓	Can be	Can be	✓
No Charge						
Non-Standard Return Sizes	✓	✓	⊘	⊘	✓	✓
Surcharge						
Banding	✓	⊘	⊘	✓ Bottom	✓ Bottom	⊘
Lining	✓	⊘	⊘	✓	✓	⊘
Override Valance Length	✓	✓	✓	✓	⊘	⊘
Valance/Cornice Fabric Banding Ties	⊘	✓	⊘	⊘	✓	⊘

Other Manh Truc Products Options Availability	Roller Shade	Panel Track	Panel Drape	Stationary Grommet Panels
No Charge				
Bead Chain Length Override	✓	⊘	⊘	⊘
Hold Downs	✓	⊘	⊘	⊘
Track Color Selection	⊘	✓	✓	⊘
Wood Edge Selection	⊘	⊘	✓	⊘
Surcharge Options				
Coating - Antimicrobial	✓	✓	✓	✓
Coating - Flame Retardant	✓	✓	✓	✓
Edge Banding	⊘	Included	✓	Included
Lining- Shade or Valance	⊘	✓	✓	✓
Panel Drape Bottom Banding	⊘	⊘	✓*	✓*
Split Draw	⊘	No Charge	✓	⊘
Straight Trim	✓	⊘	⊘	⊘
Valance Height - Addtl 12"	✓	⊘	⊘	⊘
Wood Pole and Finials	⊘	⊘	✓	⊘

* Some Panel Drape fabrics cannot have bottom banding due to flaring. See page 9.

Pricing

Manh Truc Flat and Hobbled Roman Shades

F1 FLAT ROMAN		▶Bacopa			▶Batang			▶Dynasty			▶Naoki			▶Sapporo		
WIDTH TO:		24"	30"	36"	42"	48"	60"	72"	84"	96"	108"	120"	132"	144"		
HEIGHT TO: 36"		\$109	129	158	176	207	252	292	345	392	436	476	526	566		
42"		116	136	167	189	220	272	312	367	418	467	510	562	606		
48"		123	143	176	198	234	285	332	389	443	494	541	595	645		
54"		129	156	185	212	245	303	352	414	469	523	575	633	685		
60"		134	163	196	220	256	320	369	436	496	550	602	665	721		
66"		140	169	207	234	274	336	392	458	520	584	638	703	759		
72"		149	176	216	245	285	354	409	480	547	615	669	741	800		
78"		158	185	229	256	298	369	429	505	576	645	703	777	838		
84"		165	194	238	269	314	389	452	529	603	674	739	813	878		
96"		176	212	256	292	340	420	489	574	654	732	802	885	954		
108"		189	227	278	314	365	456	529	620	707	793	867	957	1035		
120"		209	249	305	345	400	496	576	676	767	858	939	1037	1118		
H1 HOBBLED ROMAN		Bacopa not available as a Hobbled Roman Shade														
WIDTH TO:		24"	30"	36"	42"	48"	60"	72"	84"	96"	108"	120"	132"	144"		
HEIGHT TO: 36"		\$132	158	194	218	254	314	363	427	489	544	591	654	703		
42"		143	172	212	238	280	345	398	467	534	593	649	714	770		
48"		156	183	227	254	298	369	429	505	576	640	701	773	833		
54"		167	198	245	276	325	400	465	543	623	694	759	835	898		
60"		176	212	258	294	345	425	496	580	663	741	811	892	966		
66"		189	227	278	314	367	456	529	620	707	791	865	954	1031		
72"		200	240	294	334	392	483	565	658	756	842	923	1015	1098		
78"		214	252	312	354	414	514	596	698	800	892	977	1078	1163		
84"		223	269	329	372	438	543	629	740	847	945	1035	1143	1230		
96"		245	294	363	414	480	596	696	816	932	1042	1143	1262	1361		
108"		272	325	398	454	529	656	765	894	1025	1145	1253	1385	1495		
120"		292	352	432	494	574	714	832	976	1114	1244	1365	1509	1630		
Ea Adttl 12" Valance		20	27	34	40	43	52	54	63	72	86	97	106	110		

F2 FLAT ROMAN		▶Aris			▶Bayani			▶Dieu			▶Jambu			▶Taipei		
WIDTH TO:		24"	30"	36"	42"	48"	60"	72"	84"	96"	108"	120"	132"	144"		
HEIGHT TO: 36"		\$147	174	212	238	278	343	396	465	529	591	647	712	768		
42"		158	185	227	254	296	365	423	498	569	633	692	764	822		
48"		165	196	238	272	314	387	452	529	603	669	737	811	876		
54"		174	209	252	285	334	409	476	560	640	712	779	860	930		
60"		183	218	267	298	352	432	505	589	676	750	822	909	979		
66"		192	232	280	316	367	458	532	623	712	793	871	959	1035		
72"		200	240	294	334	389	478	558	654	747	835	916	1008	1089		
78"		212	252	309	349	407	505	587	689	785	878	961	1062	1145		
84"		220	267	323	365	427	529	616	720	820	921	1006	1111	1199		
96"		238	287	349	398	463	574	669	783	892	999	1098	1210	1305		
108"		256	309	380	429	503	620	725	849	969	1085	1188	1309	1414		
120"		285	340	416	469	545	678	789	920	1052	1174	1289	1419	1531		
H2 HOBBLED ROMAN																
WIDTH TO:		24"	30"	36"	42"	48"	60"	72"	84"	96"	108"	120"	132"	144"		
HEIGHT TO: 36"		\$180	216	267	298	349	432	500	587	672	746	815	898	970		
42"		198	236	289	327	385	472	547	643	734	817	892	988	1062		
48"		214	252	312	352	414	509	592	694	794	885	968	1069	1152		
54"		229	274	336	383	445	552	640	752	856	954	1046	1154	1244		
60"		243	292	358	405	474	587	685	803	916	1024	1118	1235	1334		
66"		258	312	385	432	507	627	732	856	980	1094	1199	1325	1426		
72"		278	332	405	463	538	669	776	914	1043	1165	1275	1410	1520		
78"		292	352	429	489	572	707	827	967	1107	1235	1354	1495	1614		
84"		309	369	456	516	603	752	874	1025	1172	1307	1432	1581	1709		
96"		340	407	503	572	667	827	965	1132	1292	1446	1583	1751	1890		
108"		369	447	552	627	732	909	1060	1245	1423	1590	1742	1922	2079		
120"		405	487	600	683	796	989	1154	1354	1549	1731	1899	2097	2263		
Ea Adttl 12" Valance		32	36	43	45	52	63	72	85	100	110	119	135	140		

Pricing

Manh Truc Flat and Hobbled Roman Shades

F3 FLAT ROMAN		▶Beijing		▶Chinda		▶Jilin		▶Sibu		▶Ulani				
		▶Caracas (72" x 85" max size)						▶Osaka		▶Tomiko				
WIDTH TO:		24"	30"	36"	42"	48"	60"	72"	84"	96"	108"	120"	132"	144"
36"		\$165	196	238	272	314	389	454	529	603	674	739	815	880
42"		176	212	254	289	340	418	483	572	649	725	797	878	948
48"		185	223	274	309	358	445	518	609	692	775	851	936	1010
54"		198	238	289	329	385	472	552	647	738	824	909	999	1078
60"		212	252	307	349	405	500	585	685	783	876	959	1060	1145
66"		220	267	325	367	427	529	618	727	827	927	1015	1120	1212
72"		234	280	343	389	454	558	652	765	874	977	1073	1183	1280
78"		245	294	358	407	474	587	687	805	920	1031	1129	1244	1347
84"		256	309	378	427	498	618	720	847	965	1082	1188	1309	1414
96"		280	336	409	467	543	676	789	923	1054	1181	1298	1432	1551
108"		303	363	445	507	589	732	856	1003	1147	1287	1412	1558	1684
120"		334	400	487	556	645	798	932	1092	1247	1394	1533	1691	1827
H3 HOBBLED ROMAN		Caracas and Sibu not available as a Hobbled Roman Shade												
WIDTH TO:		24"	30"	36"	42"	48"	60"	72"	84"	96"	108"	120"	132"	144"
36"		\$198	238	289	329	385	476	554	649	740	826	903	999	1076
42"		218	258	320	360	423	523	612	714	814	912	997	1103	1188
48"		236	283	347	394	458	569	660	774	885	990	1087	1199	1293
54"		254	305	372	425	498	616	718	843	960	1073	1179	1300	1406
60"		274	327	400	456	532	658	769	905	1032	1154	1266	1399	1509
66"		289	352	429	489	569	705	827	967	1105	1237	1356	1500	1619
72"		309	372	458	520	609	754	880	1034	1180	1325	1453	1601	1731
78"		329	396	487	554	645	803	938	1098	1256	1406	1542	1704	1841
84"		349	420	514	585	683	849	994	1165	1329	1491	1637	1805	1951
96"		385	465	569	649	756	940	1100	1289	1476	1652	1816	2005	2166
108"		423	512	627	716	832	1034	1214	1423	1625	1821	2003	2209	2389
120"		460	558	685	778	909	1132	1325	1552	1776	1989	2184	2411	2611
Ea Addtl 12" Valance		36	40	45	52	60	74	92	105	114	133	142	158	176
F4 FLAT ROMAN		▶Akela		▶Kaila		▶Kazuki		▶Sasarido		▶Waja				
		▶Chakra		▶Kato		▶Lada		▶Srilinka		▶Zhen				
WIDTH TO:		24"	30"	36"	42"	48"	60"	72"	84"	96"	108"	120"	132"	144"
36"		\$185	223	274	309	358	443	518	609	692	775	851	936	1013
42"		200	243	292	334	389	478	560	656	747	838	923	1013	1100
48"		216	256	314	356	416	512	600	703	803	898	988	1089	1179
54"		229	276	334	383	443	547	643	754	858	961	1060	1165	1262
60"		243	292	354	405	469	580	683	800	912	1024	1123	1239	1343
66"		256	309	378	429	500	618	725	849	967	1087	1195	1318	1423
72"		272	327	398	456	527	652	765	900	1025	1152	1266	1394	1509
78"		285	345	420	478	556	689	809	947	1080	1215	1336	1473	1594
84"		298	363	440	505	583	725	852	996	1138	1278	1406	1551	1677
96"		327	396	480	552	640	796	932	1094	1249	1401	1540	1700	1841
108"		356	432	527	600	696	867	1018	1192	1363	1527	1682	1854	2007
120"		394	474	576	656	760	945	1109	1296	1483	1666	1830	2018	2182
H4 HOBBLED ROMAN		Lada and Zhen not available as a Hobbled Roman Shade												
WIDTH TO:		24"	30"	36"	42"	48"	60"	72"	84"	96"	108"	120"	132"	144"
36"		\$232	276	336	385	447	554	647	758	865	968	1062	1172	1266
42"		252	305	369	423	494	614	714	836	958	1071	1177	1298	1403
48"		276	332	405	463	536	667	778	914	1043	1168	1287	1417	1531
54"		296	360	440	503	583	725	849	994	1136	1273	1401	1542	1670
60"		320	389	472	540	627	778	914	1072	1223	1374	1509	1666	1801
66"		345	416	507	580	676	836	983	1149	1316	1475	1625	1792	1937
72"		365	445	543	620	720	894	1052	1229	1405	1578	1738	1915	2074
78"		392	472	578	658	765	952	1118	1312	1500	1682	1852	2043	2211
84"		414	503	614	700	812	1014	1189	1392	1592	1787	1967	2166	2346
96"		458	556	680	776	905	1125	1323	1549	1772	1987	2191	2411	2615
108"		505	616	752	858	996	1240	1460	1709	1954	2196	2418	2665	2887
120"		552	672	818	940	1089	1356	1598	1869	2138	2402	2644	2916	3158
Ea Addtl 12" Valance		38	45	54	58	67	92	103	118	132	149	164	182	196

Pricing

Manh Truc Flat and Hobbled Roman Shades

F5 FLAT ROMAN		► Bengali		► Kaliko		► Maka		► Miya		► Taishan				
		► Hanoi		► Kwan		► Malie								
WIDTH TO:		24"	30"	36"	42"	48"	60"	72"	84"	96"	108"	120"	132"	144"
HEIGHT TO:	36"	\$214	254	309	354	409	507	592	694	794	887	975	1073	1163
	42"	232	278	334	383	443	547	643	754	858	961	1060	1165	1264
	48"	245	296	358	409	474	587	689	807	923	1035	1141	1253	1356
	54"	263	316	385	440	509	629	740	867	989	1109	1221	1345	1457
	60"	278	336	407	467	540	669	789	920	1052	1181	1300	1432	1554
	66"	294	356	432	498	574	712	836	980	1116	1257	1383	1524	1650
	72"	312	380	460	523	609	754	885	1038	1187	1334	1466	1616	1751
	78"	329	398	483	554	643	798	938	1096	1254	1408	1551	1706	1852
	84"	347	420	509	583	678	840	987	1154	1320	1482	1632	1798	1949
	96"	380	460	558	640	740	920	1083	1267	1449	1630	1794	1978	2144
	108"	414	503	612	698	809	1003	1183	1387	1583	1778	1960	2162	2341
120"	456	552	669	765	883	1098	1292	1509	1725	1937	2135	2350	2548	

H5 HOBBLED ROMAN		Hanoi and Taishan not available as a Hobbled Roman Shade												
WIDTH TO:		24"	30"	36"	42"	48"	60"	72"	84"	96"	108"	120"	132"	144"
HEIGHT TO:	36"	\$256	309	380	429	500	620	727	852	974	1089	1195	1318	1426
	42"	283	343	418	476	554	687	805	943	1078	1210	1329	1464	1583
	48"	309	372	456	520	605	752	880	1032	1178	1325	1455	1603	1738
	54"	336	405	498	567	656	816	960	1125	1285	1444	1587	1749	1893
	60"	360	438	534	612	707	880	1036	1212	1387	1558	1713	1888	2045
	66"	389	472	574	656	763	947	1114	1305	1492	1677	1845	2034	2205
	72"	416	505	616	703	814	1016	1194	1398	1598	1796	1976	2178	2359
	78"	440	536	654	752	869	1080	1274	1489	1703	1913	2106	2323	2517
	84"	467	572	694	796	923	1147	1352	1583	1809	2032	2238	2469	2674
	96"	518	634	772	885	1027	1278	1507	1765	2016	2267	2499	2752	2986
	108"	574	698	852	980	1136	1412	1665	1949	2227	2505	2761	3044	3300
120"	627	765	932	1072	1240	1547	1823	2134	2438	2743	3026	3333	3614	
Ea Addtl 12" Valance		45	54	63	67	85	105	120	136	163	182	200	214	238

F6 FLAT ROMAN		► Khan		► Lani		► Lea		► Malana		► Okalani				
WIDTH TO:		24"	30"	36"	42"	48"	60"	72"	84"	96"	108"	120"	132"	144"
HEIGHT TO:	36"	\$227	276	332	380	440	543	640	747	854	959	1055	1163	1262
	42"	245	296	360	414	476	592	696	816	929	1046	1154	1271	1379
	48"	267	323	389	445	514	640	754	880	1003	1129	1244	1374	1491
	54"	285	347	418	478	554	687	809	947	1083	1219	1343	1480	1603
	60"	303	367	445	512	589	734	867	1016	1156	1302	1437	1581	1715
	66"	323	394	474	545	629	783	923	1080	1232	1390	1531	1688	1830
	72"	343	416	505	580	669	832	983	1147	1314	1477	1630	1794	1944
	78"	360	440	534	614	707	880	1038	1216	1389	1565	1724	1902	2061
	84"	383	465	565	647	747	927	1098	1283	1465	1650	1821	2007	2175
	96"	418	512	620	714	825	1025	1212	1414	1618	1823	2009	2214	2402
	108"	458	560	680	778	903	1118	1325	1552	1772	1996	2205	2429	2633
120"	505	616	743	854	987	1225	1447	1692	1932	2175	2402	2647	2873	

H6 HOBBLED ROMAN		Khan not available as a Hobbled Roman Shade												
WIDTH TO:		24"	30"	36"	42"	48"	60"	72"	84"	96"	108"	120"	132"	144"
HEIGHT TO:	36"	\$278	336	409	469	543	678	796	929	1063	1192	1316	1450	1569
	42"	309	378	458	523	605	754	885	1036	1183	1331	1466	1616	1751
	48"	340	414	503	576	663	827	976	1140	1303	1464	1614	1778	1931
	54"	367	452	545	627	727	905	1065	1247	1425	1601	1765	1946	2110
	60"	398	487	589	680	785	978	1154	1349	1543	1738	1915	2108	2288
	66"	429	523	638	734	847	1054	1247	1454	1665	1872	2065	2279	2469
	72"	460	565	685	785	909	1132	1336	1560	1785	2012	2218	2445	2651
	78"	494	600	729	840	969	1207	1429	1669	1909	2148	2371	2613	2837
	84"	520	638	774	889	1032	1285	1518	1776	2029	2285	2521	2781	3017
	96"	580	714	867	996	1152	1436	1696	1985	2267	2557	2822	3109	3376
	108"	643	789	958	1103	1274	1587	1880	2196	2512	2835	3127	3446	3742
120"	703	865	1049	1209	1396	1740	2063	2412	2756	3107	3430	3782	4103	
Ea Addtl 12" Valance		49	56	67	83	96	112	132	158	178	200	220	247	265

Surcharges

Manh Truc Roman Shades

Width Based Surcharges (add to standard rectangular price)											
WIDTH TO:	24"	30"	36"	42"	48"	60"	72"	84"	96"	108"	120"
Quick Lift or Traditional Clutch	No Charge										See CareRING Cordless Max Size Charts on page 6 and 7 To price a Lined Valance, Straight or Railroaded Cornice use the shade lining surcharge x .30
CareRING Cordless System	\$65	65	69	73	78	85	100	107			
Top Down/Bottom Up	56	60	67	78	85	98	107	116	127		
Lining - Light Filtering	120	127	134	147	160	178	192	198	205		
Lining - Opaque	165	176	185	198	223	243	267	274	283		
Wood Bottom Hem	36	40	45	47	52	58	63				
Straight Gimp/Trim (per row)	34	38	43	45	52	63	67	76	98	120	143

L1 Duo Shade Liner Surcharge ALL LIGHT FILTERING LINING COLORS									
WIDTH TO:	24"	30"	36"	42"	48"	60"	72"	84"	
HEIGHT TO:	36"	\$76	96	105	123	132	163	189	223
	42"	92	109	123	143	156	187	225	256
	48"	98	116	125	147	158	192	229	265
	54"	103	125	140	165	178	218	258	296
	60"	116	140	158	183	200	243	289	334
	66"	127	156	174	205	223	269	320	367
	72"	134	158	176	207	227	274	325	374
	78"	140	174	192	227	245	298	354	407
	84"	154	187	212	245	269	327	385	445
	96"	169	207	229	269	292	354	420	483

L2 Duo Shade Liner Surcharge ALL OPAQUE LINING COLORS									
WIDTH TO:	24"	30"	36"	42"	48"	60"	72"	84"	
HEIGHT TO:	36"	\$103	125	143	169	185	227	269	312
	42"	118	147	165	189	212	258	309	356
	48"	123	152	172	200	223	272	323	374
	54"	136	169	192	227	249	305	363	420
	60"	154	187	214	249	278	340	403	465
	66"	169	207	236	274	305	372	443	512
	72"	174	214	240	285	312	383	456	527
	78"	187	232	265	307	340	418	494	572
	84"	205	249	285	334	367	452	534	618
	96"	223	274	312	365	405	498	587	680

Valance/Cornice Ordered Separately											
WIDTH TO:	24"	30"	36"	42"	48"	60"	72"	84"	96"	108"	120"
Straight or Railroaded Cornice - Price Group 1	\$83	98	112	129	149	180	216	249	287	314	354
Straight or Railroaded Cornice - Price Group 2	89	103	118	136	158	194	227	265	305	336	378
Straight or Railroaded Cornice - Price Group 3	92	109	123	149	167	200	240	278	320	356	394
Straight or Railroaded Cornice - Price Group 4	96	112	127	154	172	214	245	292	329	367	407
Straight or Railroaded Cornice - Price Group 5	100	118	134	160	180	225	265	307	356	392	440
Straight or Railroaded Cornice - Price Group 6	103	123	140	167	189	234	272	314	360	398	445
Hobbled Cornice or Waterfall Valance - Price Group 1	100	114	134	156	176	218	258	300	345		
Hobbled Cornice or Waterfall Valance - Price Group 2	107	123	140	167	189	234	274	314	367		
Hobbled Cornice or Waterfall Valance - Price Group 3	109	129	147	176	198	243	289	332	385		
Hobbled Cornice or Waterfall Valance - Price Group 4	112	134	154	185	205	254	294	352	394		
Hobbled Cornice or Waterfall Valance - Price Group 5	120	140	160	192	218	269	314	369	427		
Hobbled Cornice or Waterfall Valance - Price Group 6	123	147	169	198	227	280	327	378	432		
Ties for Cornice	20	23	25	32	36	40	45	52	58	67	74
Majesty, Noble, or Camelot Wood Valance	85	89	92	100	109	138	158	180	209	236	263

For Straight Cornice: Max width = Fabric width
To price a Lined Straight or Railroaded Cornice use the shade lining surcharge x .30

Arch Surcharges (add to price at highest height and widest width)			
Standard Arch	\$140		
WIDTH TO:	36"	48"	60"
Framed Arch	\$500	585	667
Routed Framed Arch	687	769	852

Other Surcharges (add to standard rectangular price)	
Clutch Metal Bead Chain (Stainless, Ant Bronze, Gun Metal, Burn Copper)	Add \$16 per shade
Twill or Fabric Banding on 2 Edges	Add \$169
Twill or Fabric Banding on 3 or 4 Edges	Add \$223
Two-On-One Headrail	Add \$67
Three-On-One Headrail	Add \$100
Mitered Headrail	Add \$47 per miter
Angle Top / Arch Top	Add \$225
Palladian Window Shelf	\$25.60 Finished; \$21.20 Unfinished

Motorization Surcharges

Manh Truc Roman Shades

System II Motorization Surcharges (add to standard rectangular price)		Surcharge
System II Radio Frequency 12V Motor Assembly (Reloadable Battery Wand, Lithium Batteries, Mounting Clips)		\$444
System II Radio Frequency 12V Motor Assembly (RF Receiver, Mounting Clips, Solar Pack)		\$578
System II Radio Frequency 12V Motor Assembly (Transformer)		\$491
System II Motor Only		\$293

Sonesse 30 Wirefree Motorization Surcharges (add to standard rectangular price)		Surcharge
Sonesse 30 Wirefree Motor		\$311
Charger for Sonesse 30 Wirefree		29
96" Extension Cable for Sonesse 30 Wirefree Charger		9

Somfy Controls and Accessories Surcharges (add to motorized shade price)		Item#	Surcharge
Single Channel Telis RF Transmitter (White), per transmitter	1810632		\$ 100
Single Channel Telis RF Transmitter (Black,Silver), per transmitter	1810639 (Silver), 1810650 (Black)		156
Five Channel Telis RF Transmitter (White), per transmitter	1810633		129
Five Channel Telis RF Transmitter (Black,Silver), per transmitter	1810641 (Silver), 1810652 (Black)		187
Sixteen Channel Telis RF Transmitter (White), per transmitter	1811081		478
Sixteen Channel Telis RF Transmitter (Silver), per transmitter	1811082		507
Single Channel Decoflex Wall Switch (White, Ivory)	1810897 (White), 1810898 (Ivory)		247
Single Channel Decoflex Wall Switch (Black)	1810899		298
Five Channel Decoflex Wall Switch (White, Ivory)	1810813 (White), 1810814 (Ivory)		256
Five Channel Decoflex Wall Switch (Black)	1810830		304
RTS Repeater	1810791		389
Charger Kit - Plug In for Solar Pack	9015781		124
24" Extension Cable for Solar Pack	9016374		16
4' Extension Wire for Battery Pack	9016736		22
8' Extension Wire for Battery Pack	9018624		24
myLink	1811264		404

EZ Charge Lithium Rechargeable Motorization Surcharges (add to standard rectangular price)		Item#	Surcharge
EZ Charge Rechargeable Motorization Version 2.0 Motor			\$ 284
EZ Charge Rechargeable Motorization X2 Motor			367
EZ Charge Rechargeable Motorization X3 Motor (not available on Flat Roman Shades)			478
Charger - One Charger required per order - sold separately	MTDCB-CHARGE		40
15 Channel Remote Control - One Remote required per order - sold separately	MTRF-REM-15NL		89
5 Channel Surface Mount Switch - sold separately	MTRF-WS5-FLUSH		69
Pulse App Interface - ARC Wifi to 433 - 2 way RF Bridge Kit - sold separately	MTRF-WIFIBRD		338
ARC Repeater - sold separately	MT02-0401-05		149
Solar Panel - sold separately	MTSOLPAN-B		109
DC Battery Motor Cable Extender 48" - sold separately	MTDCB-CBLXT48		13
DC Battery Motor Cable Extender 96" - sold separately	MTDCB-CBLXT96		18
Serial Con Kit - sold separately	MTSER-BASE-KIT		151
Sun Sensor - sold separately	MTRF-SUNSENS		56

Auto-Wand Motorization Surcharge (add to standard rectangular price)		Item#	Surcharge
Auto-Wand Battery Operated Wand Control Motorization Version 2.0 Motor			\$160
6' Micro USB Charger - sold separately	MTPS-USBCABLE		20

Pricing Manh Truc Roller Shades

RL1 ROLLER SHADE		▶Dynasty			▶Naoki				
WIDTH		24"	30"	36"	42"	48"	60"	72"	84"
HEIGHT	36"	§136	158	176	196	218	256	296	340
	42"	140	165	183	207	232	274	314	358
	48"	147	169	194	216	240	287	332	380
	54"	154	176	200	227	252	298	349	398
	60"	160	183	209	236	263	314	363	418
	66"	165	192	218	245	276	327	383	438
	72"	169	198	227	254	285	343	398	456
	78"	176	207	236	267	296	356	416	474
	84"	180	212	243	276	307	367	429	496
Addtl 12" Valance		20	25	32	38	43	49	52	60

RL2 ROLLER SHADE		▶Bayani		▶Dieu		▶Jambu			
WIDTH		24"	30"	36"	42"	48"	60"	72"	84"
HEIGHT	36"	§180	212	238	267	294	349	405	463
	42"	192	220	247	278	309	367	427	489
	48"	198	229	258	292	327	389	452	516
	54"	207	238	274	305	343	407	474	543
	60"	214	247	285	320	356	427	498	572
	66"	220	256	294	332	372	447	520	594
	72"	232	269	307	347	389	465	543	623
	78"	238	278	320	358	403	483	567	649
	84"	245	287	332	372	418	505	589	678
Addtl 12" Valance		32	36	43	45	52	63	72	85

RL3 ROLLER SHADE		▶Chinda		▶Osaka		▶Ulani			
WIDTH		24"	30"	36"	42"	48"	60"	72"	84"
HEIGHT	36"	§205	236	269	298	334	400	465	532
	42"	214	247	283	316	354	425	496	567
	48"	223	258	296	334	372	447	523	600
	54"	234	274	312	352	394	472	554	634
	60"	243	285	327	367	414	498	580	669
	66"	252	296	343	387	432	520	612	700
	72"	263	309	356	403	454	545	640	736
	78"	274	323	369	420	472	572	669	769
	84"	283	334	387	438	494	594	698	805
Addtl 12" Valance		34	38	45	49	58	69	89	100

Roller Shade Surcharges (add to standard rectangular price)									
WIDTH		24"	30"	36"	42"	48"	60"	72"	84"
Straight Gimp/Trim (per row)		§34	38	43	45	52	65	69	78

Pricing Manh Truc Roller Shades

RL4 ROLLER SHADE		► Kaila	► Kazuki	► Sasarido	► Waja				
WIDTH		24"	30"	36"	42"	48"	60"	72"	84"
HEIGHT	36"	\$223	263	298	340	380	456	532	609
	42"	238	278	320	358	403	483	569	652
	48"	249	292	336	383	427	516	603	694
	54"	263	309	356	403	454	545	640	736
	60"	276	325	372	423	476	578	678	778
	66"	287	340	394	445	503	609	714	820
	72"	298	354	409	467	527	638	752	865
	78"	312	369	429	489	552	669	789	909
	84"	325	387	447	509	576	698	825	949
Addtl 12" Valance		36	45	54	58	67	92	103	118

RL5 ROLLER SHADE		► Miya							
WIDTH		24"	30"	36"	42"	48"	60"	72"	84"
HEIGHT	36"	\$252	296	343	387	432	520	609	698
	42"	269	314	363	409	463	558	652	752
	48"	283	334	387	438	494	592	696	803
	54"	296	352	407	463	520	629	740	852
	60"	312	369	429	487	547	667	783	905
	66"	327	389	454	514	578	703	827	956
	72"	343	407	474	538	609	740	872	1003
	78"	356	425	498	567	638	776	916	1056
	84"	369	445	516	589	667	812	960	1107
Addtl 12" Valance		45	54	63	67	85	105	120	136

Roller Shade Surcharges (add to standard rectangular price)									
WIDTH	24"	30"	36"	42"	48"	60"	72"	84"	
Straight Gimp/Trim (per row)	\$34	38	43	45	52	65	69	78	

Pricing

Manh Truc Panel Track

Wand Control option is available on shades up to 96" in length
Cord Control option is available on shades up to 108" in length

PT1 PANEL TRACK		▶ Dynasty								
WIDTH		48"	60"	72"	84"	96"	108"	120"	132"	144"
HEIGHT	48"	\$285	334	389	505	560	620	674	809	874
	60"	312	365	427	552	612	680	736	880	956
	72"	340	398	467	600	663	736	800	956	1032
	84"	365	436	507	649	716	794	865	1027	1109
	96"	394	467	543	696	772	854	927	1100	1189
	108"	420	500	580	745	823	912	992	1174	1267

PT2 PANEL TRACK		▶ Aris			▶ Bayani		▶ Jambu			
WIDTH		48"	60"	72"	84"	96"	108"	120"	132"	144"
HEIGHT	48"	\$303	356	418	540	598	663	720	867	936
	60"	334	394	463	594	656	729	792	945	1023
	72"	363	432	505	647	714	792	863	1027	1109
	84"	396	467	545	698	774	856	932	1107	1198
	96"	425	505	589	752	832	923	1000	1187	1280
	108"	456	540	632	805	892	987	1072	1269	1369

PT3 PANEL TRACK		▶ Jilin			▶ Osaka		▶ Tomiko		▶ Ulani	
WIDTH		48"	60"	72"	84"	96"	108"	120"	132"	144"
HEIGHT	48"	\$320	378	443	567	627	696	756	905	978
	60"	354	418	489	629	696	772	843	998	1080
	72"	392	463	540	692	765	849	925	1094	1180
	84"	425	507	592	752	834	925	1005	1189	1283
	96"	465	547	640	814	905	1000	1089	1283	1385
	108"	500	592	692	876	972	1078	1172	1378	1487

PT4 PANEL TRACK		▶ Kazuki			▶ Waja					
WIDTH		48"	60"	72"	84"	96"	108"	120"	132"	144"
HEIGHT	48"	\$329	389	456	580	647	716	778	927	1000
	60"	367	440	512	652	725	805	874	1034	1116
	72"	409	485	569	725	803	887	969	1143	1234
	84"	452	536	627	794	880	976	1063	1249	1347
	96"	489	585	685	865	960	1060	1158	1356	1463
	108"	534	634	743	934	1036	1149	1252	1463	1580

PT5 PANEL TRACK		▶ Bengali			▶ Hanoi		▶ Miya			
WIDTH		48"	60"	72"	84"	96"	108"	120"	132"	144"
HEIGHT	48"	\$349	414	483	618	685	758	825	978	1056
	60"	394	467	545	694	772	854	932	1096	1187
	72"	440	520	609	772	858	952	1036	1216	1314
	84"	483	576	674	852	943	1047	1143	1336	1445
	96"	529	632	736	929	1032	1145	1247	1456	1574
	108"	574	685	803	1005	1118	1238	1352	1576	1700

Surcharges Manh Truc Panel Track

Panel Track Lining Surcharge for Light Filtering Lining										
WIDTH		48"	60"	72"	84"	96"	108"	120"	132"	144"
HEIGHT	48"	\$120	143	165	189	214	249	272	296	316
	60"	143	176	205	229	258	300	327	363	385
	72"	165	205	234	269	305	354	385	423	456
	84"	192	232	269	309	349	407	447	480	527
	96"	216	263	305	352	392	460	503	543	592
	108"	243	294	343	385	438	516	563	612	656

Panel Track Lining Surcharge for Opaque Lining										
WIDTH		48"	60"	72"	84"	96"	108"	120"	132"	144"
HEIGHT	48"	\$158	185	218	249	280	325	356	389	416
	60"	185	232	265	298	338	396	427	474	505
	72"	218	265	307	352	398	463	505	554	598
	84"	252	300	352	403	458	534	585	632	689
	96"	285	340	398	460	512	600	654	712	776
	108"	320	385	449	505	574	676	736	800	863

Optional Panel Track Banding Surcharges (add to Panel Track price) 1 1/4" or 3" Fabric Banding	\$192 per opening
---	-------------------

Valance or Cornice Ordered Separately												
WIDTH TO:		24"	30"	36"	42"	48"	60"	72"	84"	96"	108"	120"
Straight or Railroaded Cornice - Price Group 1		\$83	98	112	129	149	180	216	249	287	314	354
Straight or Railroaded Cornice - Price Group 2		89	103	118	136	158	194	227	265	305	336	378
Straight or Railroaded Cornice - Price Group 3		92	109	123	149	167	200	240	278	320	356	394
Straight or Railroaded Cornice - Price Group 4		96	112	127	154	172	214	245	292	329	367	407
Straight or Railroaded Cornice - Price Group 5		100	118	134	160	180	225	265	307	356	392	440
Straight or Railroaded Cornice - Price Group 6		103	123	140	167	189	234	272	314	360	398	445
Hobbled Cornice or Waterfall Valance - Price Group 1		100	114	134	156	176	218	258	300	345		
Hobbled Cornice or Waterfall Valance - Price Group 2		107	123	140	167	189	234	274	314	367		
Hobbled Cornice or Waterfall Valance - Price Group 3		109	129	147	176	198	243	289	332	385		
Hobbled Cornice or Waterfall Valance - Price Group 4		112	134	154	185	205	254	294	352	394		
Hobbled Cornice or Waterfall Valance - Price Group 5		120	140	160	192	218	269	314	369	427		
Hobbled Cornice or Waterfall Valance - Price Group 6		123	147	169	198	227	280	327	378	432		
Ties for Cornice		20	23	25	32	36	40	45	52	58	67	74
Majesty or Camelot Wood Valance		85	89	92	100	109	138	158	180	209	236	263

For Straight Cornice: Max width = Fabric width
 To price a Lined Straight or Railroaded Cornice use the shade lining surcharge x .30

Pricing Manh Truc Panel Drape

PD1 PANEL DRAPE		▶ Batang (94" height)			▶ Dynasty (118" height)				
		WIDTH	36"	48"	60"	72"	84"	96"	108"
HEIGHT	48"	\$236	294	347	405	458	516	572	627
	60"	272	334	396	458	520	583	643	705
	72"	305	374	445	514	580	652	718	789
	84"	340	416	489	567	643	716	794	869
	96"	374	458	538	623	703	785	869	947
	108"	427	525	616	712	801	896	992	1076
	118"	505	622	729	842	944	1058	1171	1265

PD2 PANEL DRAPE		▶ Aris (118" height)			▶ Dieu (94" height)				
		▶ Bayani (94" height)			▶ Jambu (118" height)				
WIDTH		36"	48"	60"	72"	84"	96"	108"	120"
HEIGHT	48"	\$265	325	385	449	512	572	636	696
	60"	303	372	440	512	580	652	720	789
	72"	340	420	498	574	654	729	807	883
	84"	380	467	554	638	725	809	894	978
	96"	420	514	605	700	796	885	980	1074
	108"	483	588	689	801	910	1008	1120	1228
	118"	574	696	811	946	1076	1189	1323	1451

PD3 PANEL DRAPE		▶ Beijing (118" height)			▶ Jilin (118" height)		▶ Tomiko (94" height)		
		▶ Chinda (118" height)			▶ Osaka (94" height)		▶ Ulani (94" height)		
WIDTH		36"	48"	60"	72"	84"	96"	108"	120"
HEIGHT	48"	\$289	358	429	503	574	640	714	785
	60"	336	416	498	578	658	738	820	898
	72"	380	472	560	654	745	832	925	1016
	84"	427	527	627	729	832	929	1032	1132
	96"	474	583	694	807	918	1025	1138	1247
	108"	546	670	798	929	1055	1176	1307	1431
	118"	650	795	948	1104	1252	1394	1550	1695

PD4 PANEL DRAPE		▶ Akela (118" height)			▶ Kato (94" height)		▶ Sasarido (94" height)		
		▶ Kaila (94" height)			▶ Kazuki (94" height)		▶ Waja (118" height)		
WIDTH		36"	48"	60"	72"	84"	96"	108"	120"
HEIGHT	48"	\$316	398	474	556	638	714	796	874
	60"	369	465	554	647	738	829	925	1016
	72"	423	527	629	738	845	945	1052	1154
	84"	476	594	709	827	943	1058	1176	1292
	96"	529	658	789	916	1047	1174	1307	1436
	108"	612	759	913	1055	1209	1354	1510	1659
	118"	729	902	1088	1254	1440	1610	1799	1977

PD5 PANEL DRAPE		▶ Bengali (94" height)			▶ Kwan (94" height)		▶ Miya (118" height)		
		▶ Hanoi (94" height)			▶ Maka (94" height)		▶ Taishan (94" height)		
WIDTH		36"	48"	60"	72"	84"	96"	108"	120"
HEIGHT	48"	\$352	443	532	623	714	800	894	980
	60"	412	518	623	727	832	936	1043	1147
	72"	474	594	712	834	952	1072	1192	1309
	84"	534	669	800	938	1074	1205	1340	1472
	96"	594	745	892	1043	1194	1340	1492	1636
	108"	686	861	1032	1204	1379	1550	1725	1890
	118"	818	1027	1231	1435	1643	1847	2056	2252

Pricing

Manh Truc Panel Drape

PD6 PANEL DRAPE		▶ Lani (94" height)			▶ Malana (94" height)				
		▶ Lea (118" height)			▶ Okalani (118" height)				
WIDTH		36"	48"	60"	72"	84"	96"	108"	120"
HEIGHT	48"	\$396	505	609	716	823	929	1036	1145
	60"	472	596	720	847	974	1096	1223	1349
	72"	543	689	832	978	1123	1265	1409	1556
	84"	616	783	940	1107	1272	1434	1598	1760
	96"	689	872	1054	1236	1420	1603	1785	1965
	108"	801	1008	1225	1433	1648	1860	2070	2278
	118"	958	1203	1467	1712	1969	2223	2473	2720

Optional Panel Drape Surcharges (add to Panel Drape price)									
WIDTH		36"	48"	60"	72"	84"	96"	108"	120"
Bottom Banding (3" Fabric) *		\$38	49	63	74	83	98	109	123
	Lining - Light Filtering	149	174	194	214	218	223	232	249
	Lining - Opaque	200	243	269	294	300	307	323	340
Split Draw		Add \$78 to the price of the Panel Drape overall shade price							

* See page 3 for fabrics not available with Bottom Banding

Panel Drape Decorative Wood Pole Surcharges (add to Panel Drape price)									
WIDTH		36"	48"	60"	72"	84"	96"	108"	120"
2" Smooth Wood Pole (Finished with Ball Finials)		\$267	296	296	332	332	398	398	398
2" Smooth Wood Pole (Finished) with End Caps		232	263	263	296	296	363	363	363

Valance or Cornice Ordered Separately												
WIDTH TO:		24"	30"	36"	42"	48"	60"	72"	84"	96"	108"	120"
Straight or Railroaded Cornice - Price Group 1		\$83	98	112	129	149	180	216	249	287	314	354
Straight or Railroaded Cornice - Price Group 2		89	103	118	136	158	194	227	265	305	336	378
Straight or Railroaded Cornice - Price Group 3		92	109	123	149	167	200	240	278	320	356	394
Straight or Railroaded Cornice - Price Group 4		96	112	127	154	172	214	245	292	329	367	407
Straight or Railroaded Cornice - Price Group 5		100	118	134	160	180	225	265	307	356	392	440
Straight or Railroaded Cornice - Price Group 6		103	123	140	167	189	234	272	314	360	398	445
Hobbled Cornice or Waterfall Valance - Price Group 1		100	114	134	156	176	218	258	300	345		
Hobbled Cornice or Waterfall Valance - Price Group 2		107	123	140	167	189	234	274	314	367		
Hobbled Cornice or Waterfall Valance - Price Group 3		109	129	147	176	198	243	289	332	385		
Hobbled Cornice or Waterfall Valance - Price Group 4		112	134	154	185	205	254	294	352	394		
Hobbled Cornice or Waterfall Valance - Price Group 5		120	140	160	192	218	269	314	369	427		
Hobbled Cornice or Waterfall Valance - Price Group 6		123	147	169	198	227	280	327	378	432		
Ties for Cornice		20	23	25	32	36	40	45	52	58	67	74
Majesty or Camelot Wood Valance		85	89	92	100	109	138	158	180	209	236	263

For Straight Cornice: Max width = Fabric width
 To price a Lined Straight or Railroaded Cornice use the shade lining surcharge x .30

Pricing

Manh Truc Stationary Grommet Panel

Note: All pricing is PER PANEL

G1 GROMMET PANEL				
▶ Batang ▶ Dynasty				
# OF GROMMETS	6	8	12	
FLAT WIDTH	32"	42"	62"	
HEIGHT	48"	\$458	516	569
	60"	494	556	618
	72"	527	596	667
	84"	563	638	712
	94"	596	680	760

G4 GROMMET PANEL				
▶ Akela ▶ Kato ▶ Sasarido ▶ Kaila ▶ Kazuki ▶ Waja				
# OF GROMMETS	6	8	12	
FLAT WIDTH	32"	42"	62"	
HEIGHT	48"	\$538	620	696
	60"	592	687	774
	72"	645	749	852
	84"	698	816	932
	94"	752	880	1009

G2 GROMMET PANEL				
▶ Aris ▶ Dieu ▶ Jambu ▶ Bayani				
# OF GROMMETS	6	8	12	
FLAT WIDTH	32"	42"	62"	
HEIGHT	48"	\$485	545	605
	60"	525	594	660
	72"	563	643	718
	84"	600	689	774
	94"	643	736	827

G5 GROMMET PANEL				
▶ Bengali ▶ Kwan ▶ Miya ▶ Hanoi ▶ Maka ▶ Taishan ▶ Kaliko ▶ Malie				
# OF GROMMETS	6	8	12	
FLAT WIDTH	32"	42"	62"	
HEIGHT	48"	\$574	663	754
	60"	634	740	845
	72"	696	816	934
	84"	756	889	1023
	94"	816	967	1114

G3 GROMMET PANEL				
▶ Beijing ▶ Jilin ▶ Tomiko ▶ Chinda ▶ Osaka ▶ Ulani				
# OF GROMMETS	6	8	12	
FLAT WIDTH	32"	42"	62"	
HEIGHT	48"	\$512	580	652
	60"	558	638	718
	72"	600	694	783
	84"	649	749	849
	94"	696	805	916

G6 GROMMET PANEL				
▶ Lani ▶ Malana ▶ Okalani ▶ Lea				
# OF GROMMETS	6	8	12	
FLAT WIDTH	32"	42"	62"	
HEIGHT	48"	\$618	727	829
	60"	694	818	943
	72"	765	912	1054
	84"	836	1003	1163
	94"	912	1094	1276

Optional Stationary Grommet Panel Surcharges (add to Grommet Panel price)			
WIDTH	36"	48"	62"
Bottom Banding (3" Fabric) *	\$38	49	63
Lining - Light Filtering	149	174	194
Lining - Opaque	200	243	269

* See [page 3](#) for fabrics not available with Bottom Banding

Product Information

Manh Truc Flat Roman Shades - Cordlock

Product Features

- Fits rectangular window openings
- Available on all Manh Truc fabrics.
- Shade forms accordion folds when raised.
- Folds are spaced approximately 7" apart.
- Rings on back of the shade provide folds.
- Shade is flat when in the down position.
- Traditional style: Headrail projection of 2" ($\pm 1/8$ "); Self-valance and cord lift system to front of shade; Flat self-valance hangs approx. 7" off the headrail with cords behind the valance. IS mount shade has no returns. OS mount shade has structured returns.
- Contemporary style: Headrail projection of 2" ($\pm 1/8$ "); Material off front - cord to the back of the shade. IS mount shade has no returns. OS mount shade has wrapped ends.
- TLC Child Safe Cord Sleeve for child safety.
- Controls on the right side.
- Color coordinated wooden tassels and cords.
- Bottom of the shade is self-hemmed.
- Lift cord is 2/3 of the shade length.
- Headrail is painted or stained to color coordinate.

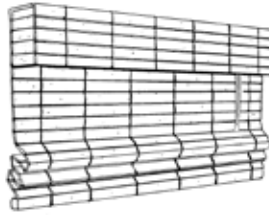

Traditional Flat Roman style with structured returns

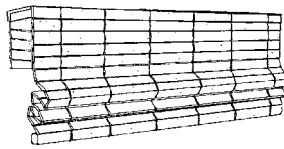

Contemporary Flat Roman style

Size Standards

See Specification Summary on [page 4](#).
Maximum Height: 120"

Important Child Safety Note

The revised American National Standard for Safety of Corded Window Covering products requires if corded window products are used in the home, cord cleats or cord tension locks must be properly installed.

Hardware Included

- New York Brackets for OS Mounts
- 3" Screws for IS Mounts

Options

- No Charge
 - Clutch System - [Page 25](#)
 - Control Side (Left)
 - 7" Flat Back Valance-Contemporary Shade IS or OS
 - Hold Down Brackets
 - New York Brackets for IS Mount
 - Optional Cord Lengths
 - Soft Returns on Shade IS or OS
 - Turned Headrail - Traditional style:
 - Headrail projection of 1";
 - Wrapped ends
 - Turned Headrail - Contemporary style:
 - Headrail projection of 1";
 - Wrapped ends
- Surcharge
 - CareRING Cordless System - [Page 26](#)
 - Edge Banding
 - Lining
 - Multiple Blinds on One Headrail
 - Specialty Shapes-Angle Top, Arch Top, Arch, Framed Arch
 - Straight Trim
 - Top Down/Bottom Up
 - Valance Length Addition - up to 12"
- Motorization - [Pages 29-29C](#)

Mounting Requirements

- Inside Mount (IS)
 - Minimum Mounting Depth: 1 1/2"
 - Mounting Depth, flush mount: 2"
- Outside Mount (OS)
 - Minimum Flat Vertical Surface: 1 1/2"

Finished Dimensions

Note: For Clutch Systems Finished Dimensions, see [page 25](#).

- Inside Mount (IS)
 - Fabric Width and Board Width: -1/2" (1/4" each side)
 - Shade Height: Ordered Height
- Outside Mount (OS)
 - Fabric Width: Ordered Width
 - Traditional Style - Board Width With Structured Returns:
 - Ordered width + 3/4"
 - Note: Traditional Style valances are 1 1/2" more than Ordered Width
 - Contemporary Style - Board Width: Ordered width
 - Shade Height: Ordered Height
- 2-on-1 Headrail Center Gap: 1/2"

Ordering Notes

- A traditional style shade is **strongly recommended** for inside (jamb to jamb) installations.
- For multiple shades on one headrail, specify control location for each shade and add clutch surcharge per shade.

Caution

- Manh Truc materials are made from **natural materials and will have visible imperfections**. Some natural patterns offer slight differences in grain and texture, especially in materials containing knots or slight surface cracks. The finest native materials in shades contain some variations in color and hue. In addition, natural materials can have a slight bow or camber so that horizontal lines or bottom hems might not be perfectly straight. Fold alignment can vary slightly, even on shades that are the same height. Shades made of natural materials tend to stretch slightly over time.

Approximate Stacking Height

When planning for an installation, the approximate amount of stacking height for a shade drop may be required. Use the information below as a GENERAL GUIDELINE ONLY. **Stacking height will vary based upon material thickness and weight for individual fabrics.**

36" Length - 9 3/4"	72" Length - 11"
48" Length - 10 1/2"	96" Length - 13"
60" Length - 10 3/4"	

Product Information

Manh Truc Hobbled Roman Shades - Cordlock

Product Features

- Fits rectangular window openings.
- Available on many Manh Truc fabrics; [See page 3](#).
- Shade has hobbled folds (approx. 5" apart) when lowered.
- Rings on back of the shade provide folds.
- Traditional style: Headrail projection of 2" ($\pm 1/8$ "); Self-valance and cord lift system to front of shade; Flat self-valance hangs approx. 7" off the headrail with cords behind the valance. IS mount shade has no returns. OS mount shade has structured returns.
- Contemporary style: Headrail projection of 2" ($\pm 1/8$ "); Material off front - cord to the back of the shade. IS mount shade has no returns. OS mount shade has wrapped ends.
- TLC Child Safe Cord Sleeve for child safety.
- Controls on the right side are standard.
- Color coordinated wooden tassels and cords.
- Bottom of the shade is self-hemmed.
- Lift cord is 2/3 of the shade length.
- Headrail is painted or stained to color coordinate.

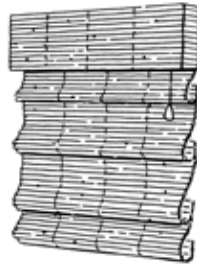

Traditional Hobbled Roman style with structured returns

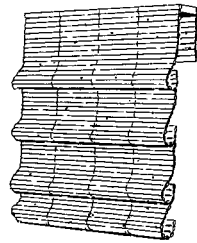

Contemporary Hobbled Roman style

Size Standards

See Specification Summary on [page 4](#).
Maximum Height: 96"

Important Child Safety Note

The revised American National Standard for Safety of Corded Window Covering products requires if corded window products are used in the home, cord cleats or cord tension locks must be properly installed.

Hardware Included

- New York Brackets for OS Mounts
- 3" Screws for IS Mounts

Options

- No Charge
 - Clutch System - [Page 25](#)
 - Control Side (Left)
 - 7" Flat Back Valance-Contemporary Shade IS or OS
 - Hold Down Brackets
 - New York Brackets for IS Mount
 - Optional Cord Lengths
 - Soft Returns on Shade IS or OS
 - Turned Headrail - Traditional style:
 - Headrail projection of 1";
 - Wrapped ends
 - Turned Headrail - Contemporary style:
 - Headrail projection of 1";
 - Wrapped ends
- Surcharge
 - CareRING Cordless System (Unlined only) - [Page 26](#)
 - Edge Banding
 - Multiple Blinds on One Headrail
 - Straight Trim
 - Valance Length Addition - up to 12"

Mounting Requirements

- Inside Mount (IS)
 - Minimum Mounting Depth: 1 1/2"
 - Mounting Depth, flush mount: 2"
- Outside Mount (OS)
 - Minimum Flat Vertical Surface,: 1 1/2"

Finished Dimensions

Note: For Clutch Systems Finished Dimensions, see [page 25](#).

- Inside Mount (IS)
 - Fabric Width and Board Width: -1/2" (1/4" each side)
 - Shade Height: Ordered Height
- Outside Mount (OS)
 - Fabric Width: Ordered Width
 - Traditional Style - Board Width with Structured Returns:
 - Ordered Width + 3/4"
 - Note: Traditional Style valances are 1 1/2" more than Ordered Width
 - Contemporary Style - Board Width: Ordered Width
 - Shade Height: Ordered Height
- 2-on-1 Headrail Center Gap: 1/2"

Approximate Stacking Height

When planning for an installation, the approximate amount of stacking height for a shade drop may be required. Use the information below as a GENERAL GUIDELINE ONLY. **Stacking height will vary based upon material thickness and weight for individual fabrics.**

36" Length - 9 3/4"	72" Length - 11"
48" Length - 10 1/2"	96" Length - 13"
60" Length - 10 3/4"	

Ordering Notes

- Exclusions: Fabrics shown as N/A on [page 3](#); Lining.
- A traditional style shade is **strongly recommended** for inside (jamb to jamb) installations.
- The hobbled folds will vary based upon the material selected. Lighter materials tend to produce flatter folds while heavier material tend to billow. Edge Banding enhances the fold.



Caution

- Manh Truc materials are made from **natural materials and will have visible imperfections**. Some natural patterns offer slight differences in grain and texture, especially in materials containing knots or slight surface cracks. The finest native materials in shades contain some variations in color and hue. In addition, natural materials can have a slight bow or camber so that horizontal lines or bottom hems might not be perfectly straight. Fold alignment can vary slightly, even on shades that are the same height. Shades made of natural materials tend to stretch slightly over time.

Product Information

Manh Truc Flat or Hobbled Roman Shades - Clutch System

Product Features

- For Flat Roman Shades refer to [page 23](#).
- For Hobbled Roman Shades refer to [page 24](#).
- Available on all Manh Truc fabrics.
- Available in Traditional Style or Contemporary Style.
- Select Quick Lift Clutch System or Traditional Clutch System.
- Quick Lift Clutch raises and lowers faster.
- Quick Lift Clutch System has a 2 1/2" return.
- Traditional Clutch System has a 2" return.
- TLC Child Safe Cord Sleeve for child safety.
- Cord Tension Lock on beaded loop chain that must be secured to the wall for the shade to operate.
- Controls on the right side.



Quick Lift Clutch System



Traditional Clutch System

Mounting Requirements

- Inside Mount (IS)
 - Minimum Mounting Depth: 1 1/2"
 - Mounting Depth, flush mount: 2 1/2" for Quick Lift Clutch System
2" for Traditional Clutch System
- Outside Mount (OS)
 - Minimum Flat Vertical Surface: 1 1/2"

Finished Dimensions

Note: For Cord Lock Finished Dimensions, see [pages 23 or 24](#).

- Inside Mount (IS)
 - Fabric Width and Board Width: -1/2" (1/4" each side)
 - Shade Height: Ordered Height
- Outside Mount (OS)
 - Fabric Width: Ordered Width
 - Traditional Style - Board Width With Structured Returns: Ordered width + 1 1/8"
 - Note: Traditional Style valances are 1 7/8" more than Ordered Width
 - Contemporary Style - Board Width: Ordered width + 3/4"
 - Shade Height: Ordered Height
- 2-on-1 Headrail Center Gap: 1/2"

Size Standards

See Specification Summary on [page 4](#).

Minimum width: 15" Quick Lift Clutch; 24" Traditional Clutch

Maximum Height: 120" Quick Lift Clutch; 96" Traditional Clutch

Hardware Included

- Quick Lift Clutch - L brackets OS Mount; 3" Screws for IS Mount
- Traditional Clutch - New York Brackets OS Mount; 3" Screws IS Mount
- Cord Tension Lock

Approximate Stacking Height

When planning for an installation, the approximate amount of stacking height for a shade drop may be required. Use the information below as a GENERAL GUIDELINE ONLY. **Stacking height will vary based upon material thickness and weight for individual fabrics.**

36" Length - 9 3/4"	72" Length - 11"
48" Length - 10 1/2"	96" Length - 13"
60" Length - 10 3/4"	

Important Child Safety Note

The revised American National Standard for Safety of Corded Window Covering products requires if corded window products are used in the home, cord tension locks must be properly installed.

Continuous Bead Chain Drops

Shade Length	Drop	Shade Length	Drop
30" - 42"	24"	78 1/16" - 90"	72"
42 1/16" - 54"	36"	90 1/16" - 102"	84"
54 1/16" - 66"	48"	Over 102"	96"
66 1/16" - 78"	60"		

- For inside mount - Chain length must be at least 6" shorter than ordered length to ensure proper tensioner installation.

Options

- No Charge
 - Clutch System - Choose Quick Lift or Traditional Clutch System
 - Control Side (Left)
 - 7" Flat Back Valance on Contemporary Shade IS or OS
 - Hold Down Brackets
 - New York Brackets for IS Mount (Traditional Clutch only)
 - Optional Bead Chain Drop
 - **P Clip Safety Tensioner**
 - Soft Returns on Shade IS or OS
- Surcharge:
 - Edge Banding
 - Lining
 - Multiple Blinds on One Headrail
 - Stainless Steel Bead Chain or Colored Metal Bead Chain
 - Straight Trim
 - Valance Length Addition - up to 12"

Ordering Notes

- A traditional style shade is **strongly recommended** for inside (jamb to jamb) installations.
- For outside mount shades, the board width is 3/4" greater than the ordered width. For a Traditional Style shade with structured returns the board width is 1 1/8" greater than the ordered width. Valances will be 1 7/8" greater than the ordered width. This allows the clutch and cord tension lock line up vertically with no contact with the fabric edge. If a wrapped end is ordered the valance will measure an additional 1/4" due to material thickness.
- If shade is ordered with wrapped ends or soft returns, the headrail will be 1/2" less than the ordered width.
- For multiple shades on one headrail, specify control location for each shade and add clutch surcharge per shade.

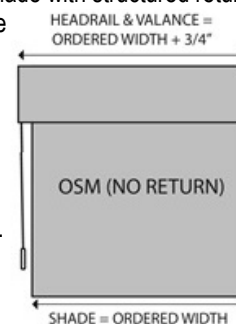

Caution

- Manh Truc materials are made from **natural materials and will have visible imperfections**. Some natural patterns offer slight differences in grain and texture, especially in materials containing knots or slight surface cracks. The finest native materials in shades contain some variations in color and hue. In addition, natural materials can have a slight bow or camber so that horizontal lines or bottom hems might not be perfectly straight. Fold alignment can vary slightly, even on shades that are the same height. Shades made of natural materials tend to stretch slightly over time.

Product Information

Manh Truc Flat Roman Shades(Unlined or Lined) - CareRING Cordless Manh Truc Hobbled Roman Shades(Unlined) - CareRING Cordless

Product Features

- Fits rectangular window openings
- Available on most Manh Truc fabrics.
See [page 4](#) for availability.
- Flat Roman - Shade forms accordion folds when raised. Shade is flat when in the down position. Folds are spaced approximately 7" apart.
- Hobbled Roman - Shade has hobbled folds (approx. 5" apart) when in the down position
- Traditional style: Headrail projection of 2 1/2" ($\pm 1/8$ "); Self-valance and cord lift system to front of shade; Flat self-valance hangs approx. 7" off the headrail with cords behind the valance. IS mount shade has no returns. OS mount shade has structured returns.
- Contemporary style: Headrail projection of 2 1/2" ($\pm 1/8$ "); Material off front - cord to the back of the shade. Shade has wrapped ends.
- TLC Child Safe Cord Sleeve for child safety.
- Rings on back of the shade provide folds.
- Controls in the center on the back side of shade.
- Color coordinated cords.
- Bottom of the shade is self-hemmed.
- Headrail is painted or stained to color coordinate.

Mounting Requirements

- Inside Mount (IS)
 - Minimum Mounting Depth: 1 1/2"
 - Mounting Depth, flush mount, CareRING Cordless: 2 1/2"
- Outside Mount (OS)
 - Minimum Flat Vertical Surface, CareRING Cordless: 1 9/16"

Finished Dimensions

- Inside Mount (IS)
 - Fabric Width and Board Width: -1/2" (1/4" each side)
 - Shade Height: Ordered Height
- Outside Mount (OS)
 - Fabric Width: Ordered Width
 - Traditional Style - Board Width with Structured Returns: Ordered Width + 3/4"
 - Note: Traditional Style valances are 1 1/2" more than Ordered Width
 - Contemporary Style - Board Width: Ordered Width
 - Shade Height: Ordered Height

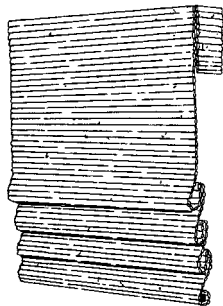

CareRING Cordless
Front - Contemporary Style
(Shown - Flat Roman)

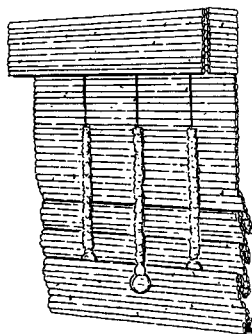

Cordless Shade
Back - Contemporary Style
(Shown - Flat Roman)

Size Standards

See Specification Summary on [page 4](#).

Minimum Height: 24"

Maximum Height: 84"

Hardware Included

- L Brackets for OS Mounts
- 3" Screws for IS Mounts

Options

- No Charge
 - 7" Flat Back Valance on Contemporary Shade IS or OS
 - Hold Down Brackets
 - Soft Returns on Shade IS or OS
- Surcharge:
 - CareRING Cordless (required surcharge)
 - Lining (on Flat Romans, not Hobbled)
 - Straight Trim
 - Valance Length Addition - up to 12"

Caution

- The springs in the CareRING Cordless system allow for the shade to raise and lower with minimal effort. Excessive force when lowering the shade can cause it to malfunction.
- Manh Truc materials are made from **natural materials and will have visible imperfections**. Some natural patterns offer slight differences in grain and texture, especially in materials containing knots or slight surface cracks. The finest native materials in shades contain some variations in color and hue. In addition, natural materials can have a slight bow or camber so that horizontal lines or bottom hems might not be perfectly straight. Fold alignment can vary slightly, even on shades that are the same height. Shades made of natural materials tend to stretch slightly over time.

Product Information

Manh Truc Roman Duo-Shades

Product Features

- Separate flat roman shade and liner shade mounted on a headrail.
- Fits rectangular window openings.
- Available on all Manh Truc fabrics.
- Contemporary style: Headrail projection of 2"($\pm 1/8$ "); Liner off the back of the headrail; shade off the front of the headrail; Cord locks between front shade and back liner. Valance has wrapped ends.
- Traditional style: Headrail projection of 2"($\pm 1/8$ "); Shade and liner off the back of the headrail; Lining cord and shade cord in front of both shades. Flat self-valance hangs approx. 7" off the headrail. IS mount shade has wrapped ends. OS mount shade has structured returns.
- Independent operation of both the woven shade and lining shade due to two separate cordlock controls.
- TLC Child Safe Cord Sleeve for child safety.
- Rings on back of the woven shade provide folds.
- Clear rods on back of the liner shade provide folds.
- Lift cord for shade is on right side; Cord for liner is on left side.
- Lift cord for shade is color coordinated to woven shade;
- Lift cords are 2/3 of the shade length.
- Bottom of the shade is self-hemmed.
- Headrail is painted or stained to color coordinate.



Size Standards

- See Specification Summary on [page 5](#).
Maximum shade width is 84"
Maximum shade length is 96"

Important Child Safety Note

The revised American National Standard for Safety of Corded Window Covering products requires if corded window products are used in the home, cord cleats or cord tension locks must be properly installed.

Hardware Included

- L Brackets for OS mount
- 3" Screws for IS mount

Options

- No Charge
 - Control Side (Shade - Left, Liner - Right)
 - Hold Down Brackets
 - Optional Cord Lengths
 - Soft Returns - IS or OS Mount
 - Turned Headrail:
 - Headrail projection of 1";
 - Wrapped ends - IS or OS Mount
- Surcharge
 - Edge Banding (Woven Shade)
 - Straight Trim

Mounting Requirements

- Inside Mount (IS)
 - Minimum Mounting Depth: 1 1/2"
 - Mounting Depth, flush mount: 2"
- Outside Mount (OS)
 - Minimum Flat Vertical Surface: 1 1/2"

Finished Dimensions

- Inside Mount (IS)
 - Fabric Width and Board Width: -1/2" (1/4" each side)
 - Shade Height: Ordered Height
- Outside Mount (OS)
 - Fabric Width: Ordered Width
 - Traditional Style - Board Width with Structured Returns:
 - Ordered width + 3/4"
 - Note: Traditional Style valances are 1 1/2" more than Ordered Width
 - Contemporary Style - Board Width: Ordered Width
 - Shade Height: Ordered Height

Approximate Stacking Height

When planning for an installation, the approximate amount of stacking height for a shade drop may be required. Use the information below as a GENERAL GUIDELINE ONLY. **Stacking height will vary based upon material thickness and weight for individual fabrics.**

36" Length - 9 3/4"	72" Length - 11"
48" Length - 10 1/2"	96" Length - 13"
60" Length - 10 3/4"	

Ordering Notes

- Exclusions: Multiple Blinds on One Headrail; Clutch system, CareRING Cordless, Top Down Bottom Up shade.
- The Duo Shade Liner surcharge is based upon which lining is selected and that price is added to the base shade price.

Caution

- Manh Truc materials are made from **natural materials and will have visible imperfections**. Some natural patterns offer slight differences in grain and texture, especially in materials containing knots or slight surface cracks. The finest native materials in shades contain some variations in color and hue. In addition, natural materials can have a slight bow or camber so that horizontal lines or bottom hems might not be perfectly straight. Fold alignment can vary slightly, even on shades that are the same height. Shades made of natural materials tend to stretch slightly over time.

Product Information

Manh Truc Woven Shades - Specialities

Flat Roman Arch

- **Template is required.**
- Flat Roman arch is stationary and will NOT raise.
- See [page 5](#) for size specifications and fabric availability.
- Pattern runs horizontally as shown in the diagram.
- Arch height cannot exceed 1/2 of the arch width.
- Standard Arch - Board depth is 7/8"; Board height is 2".
- Material is secured to a wooden frame with staples, staples are hidden using gimp around the arch top.
- Button catches are sent for installation.

Ordering Notes

- Price shade using highest point of the arch to bottom height, then add the Arch surcharge.



Manh Truc Framed Arch

- **Template is required.**
- See [page 5](#) for size specifications and fabric availability.
- Framed Manh Truc non-operable arch provides a finished look in the arch opening and minimizes the light gap in the arch opening.
- Routed Framed Arch provides a routed edge for easier installation and reduced light gaps. Select a routed frame for the arch portion only or for the full frame.
- Framed Arch - Frame depth is 1"; Frame height is 1 5/8".
- Routed Framed Arch - Frame depth is 1"; Frame height is 2".
- Select from one of eight fine furniture finishes: Gardenia, Navajo White, Natural, Cottage Pine, Buckeye, Mahogany, Java Roast or Ebony Wash. Color Thunder is also available - see Heartland Woods sample book or the online Materials Library.

Ordering Notes

- Price shade using highest point of the arch to bottom height, then add the Framed Arch or Routed Framed Arch width-based surcharge.



On-Line Template Service

- We can produce a template for you for a flat fee.
- To order a factory-made template go to the Lafayette web site at www.lafayetteinteriorfashions.com and log in to the Dealer Center / Ordering and Quoting.
- You may print and fill out a template order form and send it to Lafayette.
- You may also complete and submit the web-based order form online.

Arch Top Flat Roman Shade

- **Template is required.**
- Fits window openings with an arched top opening.
- See [page 5](#) for size specifications and fabric availability.
- Shade operates as standard shade and raises to the bottom of the arch.
- Arch height cannot exceed 1/2 of the arch width.
- Arch Top - Board depth is 1"; Board height is 2".
- Material is secured to a wooden frame with staples. Staples are hidden using gimp around the arch top edge.
- Choose traditional or contemporary style; Flat valance length is approx. 7" longer than the bottom of the arch portion; Valance is attached with velcro; cord controls can be on either side.
- If a lined arch top flat roman shade is ordered, the lining extends into the arch.
- Edge Banding is available in banding configuration VBH2 only.
- Returns are not available.
- L-brackets for easy installation.

Ordering Notes

- Exclusions: Clutch system
- Price shade using highest point of arch to bottom height, then add the Arch Top surcharge.

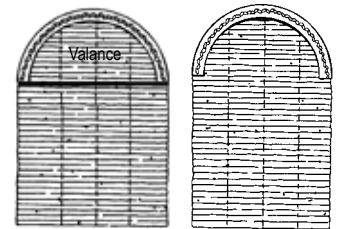

Traditional Style Arch Top Shade

Contemporary Style Arch Top Shade

Angle Top Flat Roman Shade

- **Diagram is required.**
- Fits window openings with a sloped top board.
- See [page 5](#) for size specifications and fabric availability.
- Shade operates as standard rectangular cord lock, shade raises only to the bottom of the angle.
- Maximum angle of slope is 35°. Angle bottom is not available.
- Material is secured to a 1" or 2" projection board with staples; staples are hidden using gimp; valance is attached using velcro.
- Shade valance is 7" long at the shortest point of slope; Cord lock is on the short side of the angle.
- If a lined angle top flat roman shade is ordered then the lining extends into the angle.
- Edge Banding is available in all banding configurations.
- Trim is available on valance hem.
- Returns are not available.
- L-brackets for easy installation.

Ordering Notes

- Exclusions: Clutch system
- Specify short point height and side (left or right) and long point height.
- Price shade using long side as height, then add the Angle Top surcharge.

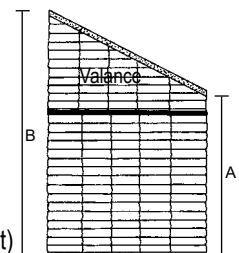

Traditional Style Angle Top Shade

Product Information

Somfy Battery Operated Series



Somfy Battery Motorization Features

- Available for most Manh Truc Flat Roman Shades.
- Maximum sizes: [Page 8](#)



System II Information (1.1Nm)

- 12V DC Motor
- Available on 1 1/2" tube
- Can be powered via 8AA Lithium batteries, Solar Pack Kit or Transformer
- Minimum width 16"
- Minimum height 24"
- Non-adjustable 28 RPM roller speed
- Compatible with all of Somfy's RTS transmitters

Sonesse 30 Wirefree Information (2Nm)

- Built in Lithium-ion rechargeable battery
- Available on 1 1/2" or 2" tube
- 96" Charger Extension Cable available (sold separately)
- Minimum width 29"
- Minimum height 24"
- Adjustable speed 10-28 RPM
- Compatible with all of Somfy's RTS transmitters

Options

Additional Power Options for System II Motor

- 12V DC Power Supply (Individual)
- 12V DC Power Supply Distributed Power (Large Applications)
- Solar Pack

Controls

- Remotes
 - 1 Channel (Black, White, Silver)
 - 5 Channel (Black, White, Silver)
 - 16 Channel (White, Silver)
- Wall Switches (Black, White, Ivory)
 - 1 Channel or 5 Channel

Finished Dimensions

- Inside Mount (IS): -1/8"
- Outside Mount (OS): Ordered width



System II Motor



Sonesse 30 Wirefree Motor



Reloadable Battery Wand with 8AA Lithium batteries



10' Transformer



Solar Pack Kit with 10 NiMH batteries



Coming soon - Sonesse 30 Wirefree Solar Panel



5' Charger

Ordering Notes

- Specify Inside or Outside Mount.
- Order Transmitter(s) or Wall Switch(s) as required.
- Check for other options required that are available.
- Choose left or right side for power cord and motor.
- Price as a standard shade, add the motor surcharge per shade and other surcharges (transmitters, etc.).
- Specify desired channel(s) for programming.
- **Window length is required** so that the limits can be set
- **Exclusions:** Season-Vue shades.

Product Information

Somfy Battery Operated Series



Somfy myLink Overview

- WiFi to RTS bridge that can control up to 16 channels of RTS motorized products using the Somfy myLink apps for iOS and Android devices.
- Using the app, users can send immediate RTS commands, create Scenes and Schedules.
- Users can access their myLinks from anywhere with the apps' remote access feature.
- Multiple myLinks can be joined within the same system for multi-zone control.
- Can also serve as an IP to RTS bridge for 3rd party control systems.
- Amazon Alexa integration

Features Summary:

- Control for up to 16 RTS channels per myLink from iOS and Android devices.
- Join up to 10 myLinks together for multi-zone control.
- Manually activate RTS products.
- Automate window shades with scenes and schedules.
- Supports Up/Down/My/Stop commands and increments control (tilt/brightness)
- Multiple users
- Remote access
- Integration with third party-systems over IP
- Compatible with Somfy Synergy™ API

Technical Specifications

- 120V AC; 50-60Hz
- Ultra Low Power Wi-Fi (802.11 b/g/n)
- 3.64 L x 2.35W x 1.95 H
- Radio Frequency:
 - RTS 433.42 MHz
 - WiFi: 2.4 GHz and 5 GHz
- iOS Version: 7 and higher
- Android Version: Jelly Bean and higher
- FCC ID: DWMNYLINK
- Operating Temp 41° F to 113° F
- Rated Current (Amps): 10 to 50 milliamps
- Insulation Class: Class II
- For Indoor Use Only
- Enclosure:
 - PE
 - UL94V-0 flame rating
 - RoHS compliant
 - UL listed
- Shipping Weight: 1 lb.

Motorization Services

- Customer Service Motorization Skill Set
 - 800-342-5523
 - motor@lafvb.com
- Technical Support by trained Customer Service Agents
- Assistance in the specification of motorization applications
- Liason between dealers/designers, electricians and home automation integrators.

Connections and Indicators:



- | | | |
|----|--------------|--|
| 1. | Setup Button | Engages setup mode |
| 2. | Status LED | <p>Solid Red: The myLink is ready to accept WiFi network information or have its PIN changed. This is the mode the myLink should be in out of the box.</p> <p>Solid Green: myLink is successfully connected to WiFi network</p> <p>Slow Blinking Green: searching for/connecting to a WiFi network/is disconnected from its know WiFi network</p> <p>Single Orange Blink: mmyLink is sending RTS commands</p> <p>Solid Orange: Firmware update mode</p> <p>Slow Blinking Red: myLink is scanning both 2.4GHz and 5GHz bands for nearby WiFi networks</p> |
| 3. | AC Prongs | AC prongs |

Wiring Best Practice:

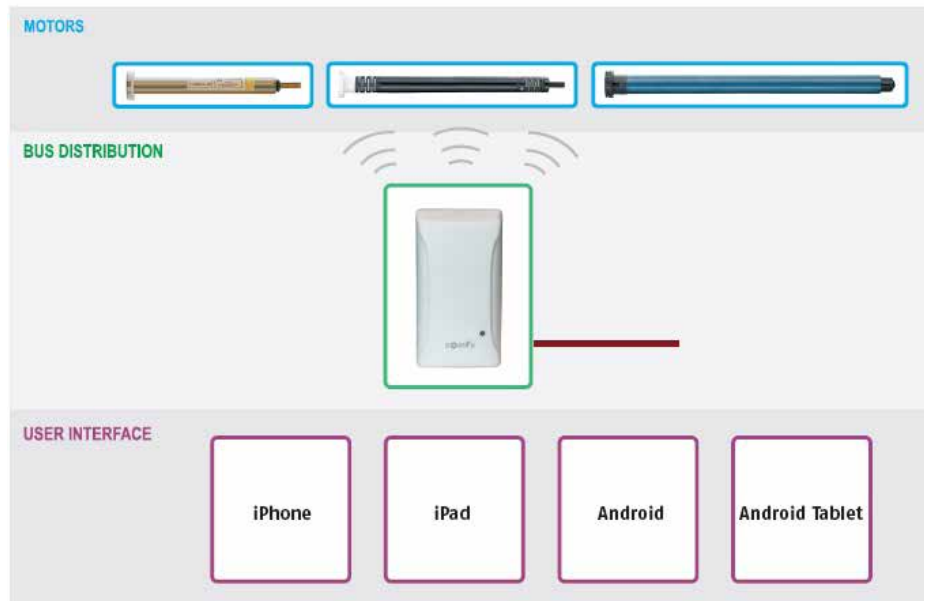

Product Information

EZ Charge™ Lithium Rechargeable Series



EZ Charge Product Features

- Available on Manh Truc Flat Roman Shades.
- Battery powered motor with remote control or wall switch or app interface (all purchased separately).
- Lithium-ion battery is internal and rechargeable.
- Remote offers up to 15 channels separately or in groups.
- Electronic stop setting.
- Rechargeable battery can offer 6 to 12 months on a single charge under normal conditions. Charger has a 12' cord sold separately. Extension cables sold separately.
- 6 hours for a full peak charge (from a complete dead to a full charge).
- Warning sound when battery charge is low.
- Economical child safe solution with no cords.
- 5 Year Motor Warranty



15 Channel Remote Control



Wall Switch



Charger with 12 foot cord



Pulse Bridge

EZ Charge Version 2.0 (1.1Nm)

- Size Standards: [Page 8A](#)
- Minimum width: 22"
- Minimum height: 24"
- Adjust speed: 40 RPM (30 RPM or 20 RPM)

EZ Charge X2 (Q-2Nm)

- Size Standards: [Page 8A](#)
- Minimum width: 32"
- Minimum height: 24"
- Adjust speed: 28 RPM (24 RPM or 20 RPM)

EZ Charge X3 (Q-3Nm)

- Size Standards: [Page 8B](#)
- Minimum width: 42"
- Minimum height: 24"
- Adjust speed: 28 RPM (24 RPM or 20 RPM)

Options

- Surcharge
 - Pulse App Integration - Arc Wifi Bridge Kit - Sold separately
 - Surface Mount Wall Switch - Sold separately
 - Remote - 15 channel (White) - Sold separately
 - Accessories - Repeater, Solar Panel, Ext Cables-Sold separately

Finished Dimensions

- Inside Mount (IS): -1/8"
- Outside Mount (OS): Ordered width

Ordering Notes

- Specify Inside or Outside Mount.
- Price as a standard shade, add the motor surcharge per shade.
- Add the Charger(s), Remote(s), and the Pulse Bridge.
- **Exclusions:** Hobbled roman shades.

Motorization Services

- Customer Service Motorization Skill Set
 - 800-342-5523 or motor@lafvb.com
- Assistance in the specification of motorization applications
- Liason between dealers/designers, electricians and home automation integrators.

EZ Charge Pulse Bridge

- Allows for app control over any of your EZ Charge Series motors.
- Set and manage up to 20 scenes; Set and manage up to 20 timers.
- Manage multiple hubs under multiple locations. Easily switch between office and home. Allows for up to 5 hubs under each location.
- Allows for third party serial integration.
- Amazon Alexa compatible.

Features Summary:

- Controls up to 30 devices per hub
- Join multiple Pulse bridges together for multi-zone control
- Plug-and-play installation
- iOS & Android compatible
- Remote access

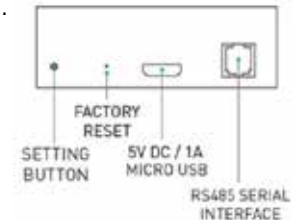

Technical Specifications

- Power input 5VDC/1A; Rated current 500mA; Rated power <2.5W
- Standby power: <300mA
- WiFi Network: 802.11 b/g/n - 2.4 GHz
- Range Coverage: 30 m for device control
- Protection: IP20
- 3.07 L x 3.07 W x .93 H; Antenna Built-in

EZ Charge Repeater

- Extends the RF operating range up to 120 ft for ARC enabled products.
- Operates by plugging the USB power adapter into a power outlet and then plugging the USB Repeater into the USB power adapter.
- Press any button on the remote control and the blue light on the USB Repeater will flash three times. This means the USB Repeater is transmitting the signal.



Product Information

Auto-Wand Motorization Version 2.0



Auto-Wand Product Features

- Available on Genesis window shades and roman shades.
- Battery operated motor with wand control.
- Economical child safe solution with no cords.
- Up or Down position controlled by button on wand.
- Top and bottom limits can be set.
- Lithium battery is internal and rechargeable.
- Wand is White, Gray or Black.
- Wand control is on either side of the shade.
- Rechargeable battery can offer 6 to 12 months on a single charge under normal conditions.
- 5 Year Motor Warranty

Size Standards

- See Size Standards on [page 8B](#).
- Maximum Area cannot be exceeded for any shade.
- Minimum width: 22"
- Minimum length: 28"

Options

- Surcharge
 - Charger - 6' Cable with Micro USB

Wand Length

Shade Length	Wand
Up to 39"	24"
39 1/16" - 54"	36"
Over 54 1/16"	48"



Auto-Wand Shade



Wand Control

Finished Dimensions

- Inside Mount (IS)
 - All systems: -1/8"
- Outside Mount (OS)
 - All systems: Ordered width

Ordering Notes

- Specify Inside or Outside Mount.
- Price as a standard shade, and add the motor surcharge per shade.

Motorization Services

- Motorization Skill Set offered in Customer Service
 - 800-342-5523
 - motor@lafvb.com
- Technical Support by trained Customer Service Agents
- Assistance in the specification of large motorization applications
- Liason between dealers/designers, electricians and home automation integrators.

Product Information

Manh Truc Roller Shades

Product Features

- Fits rectangular window openings.
- Available on many Manh Truc fabrics; See [page 3](#).
- A 3/4" x 3 1/2" board is used for all roller shades 50" or less in height.
- A 3/4" x 5 1/2" board is used for all roller shades greater than 50" in height.
- 7" self-valance off the front.
- OS mount shade has structured returns.
- IS mount shade has no returns.
- Operated with beaded loop chain.
- Bead chain loop is 2/3 of the shade length.
- SL Series hooked clutch and spring pin-end are mounted on a board for easy installation.
- SL clutch has nylon fiberglass filled construction for quieter performance and added durability.
- SL Clutch Brackets are mounted on the board for ease of installation.
- Fabric comes off the back of the roller.
- Bottom of the shade is self-hemmed.

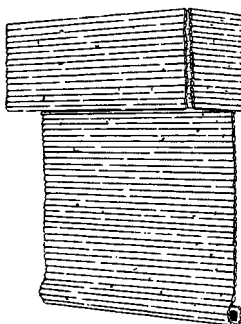

Size Standards

- See Specification Summary on [page 9](#).
- Maximum Width: 84"
 - Minimum Width: 15"
 - Maximum Height: 84"

Important Child Safety Note

The revised American National Standard for Safety of Corded Window Covering products requires if corded window products are used in the home, cord cleats or cord tension locks must be properly installed.

Continuous Bead Chain Drops

Shade Length	Drop	Shade Length	Drop
30" - 42"	24"	54 1/16" - 66"	48"
42 1/16" - 54"	36"	66 1/16" - 78"	60"
		78 1/16" - 84"	72"

Hardware Included

- Installation Brackets
- Cord Tension Lock

Options

- No Charge
 - 5 1/2" board return for shade heights 50" or less
 - Hold Down Brackets
 - Optional Continuous Bead Chain Loop Lengths
 - **P Clip Safety Tensioner**
- Surcharge
 - Straight Trim on Shade Hem
 - Straight Trim on Shade Valance
 - Valance Length Addition - up to 12"

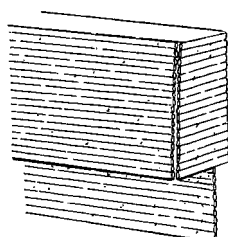

Outside Mount
with 7" long return

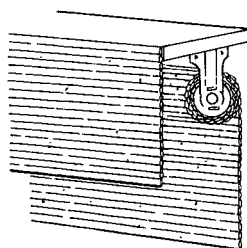

5 1/2" Board for
shades greater than
50" long
(Inside Mount shown)

Mounting Requirements

• Inside Mount (IS) - Minimum Mounting Depth	
- 3 1/2" Board - For shade 50" or less	2"
- 5 1/2" Board - For shade greater than 50"	2 1/2"
• Inside Mount (IS) - Min Mounting Depth - Flush Mount	
- 3 1/2" Board - For shade 50" or less	3 1/2"
- 5 1/2" Board - For shade greater than 50"	5 1/2"
• Outside Mount (OS) - Minimum Flat Vertical Surface: 2"	

Ordering Notes

- Exclusions: Fabrics shown as N/A on [page 3](#).
- Not available with lining or edge banding.
- Consider board width for shades in the same room with varied lengths.
- Clutch brackets are universal for inside mount, outside mount, ceiling mount, standard or reverse roll shades.

Caution

- Manh Truc materials are made from **natural materials and will have visible imperfections**. Some natural patterns offer slight differences in grain and texture, especially in materials containing knots or slight surface cracks. The finest native materials in shades contain some variations in color and hue. In addition, natural materials can have a slight bow or camber so that horizontal lines or bottom hems might not be perfectly straight. Fold alignment can vary slightly, even on shades that are the same height. Shades made of natural materials tend to stretch slightly over time.

Finished Dimensions

- Inside Mount (IS)
 - Board Width: -1/8"
 - Shade Width: - 1 1/8"
- Outside Mount (OS)
 - Board Width: Ordered width
 - Shade Width: - 1 1/8"

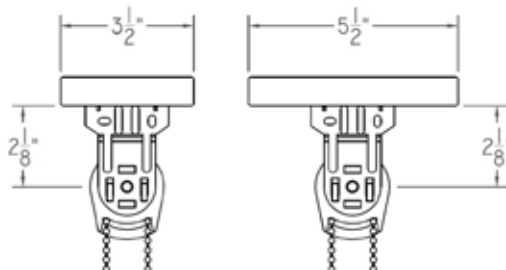

Product Information

Manh Truc Panel Track

Product Features

- Fits rectangular window openings.
- Available on many Manh Truc fabrics; See [page 3](#).
- **Edge Banding is required on Panel Track shades.**
- 1 1/4" Twill Banding; Select from Twill Sample Card.
- One Way Draw or Split Draw.
- Cord Draw Control.
- Split Draw with cord draw always uses a 5 channel track.
- Front Panel Draw is standard (panels stack in front of each other with fixed panel closest to the window side).
- Brown or White aluminum track system.
- Track can be ceiling mounted or wall mounted
- Track uses sturdy delrin wheeled carriers.
- Material is attached with hook and loop system and reinforced with screws.
- Approximate 3" panel overlap provides uniform view and minimizes light leakage.
- Aluminum bar is inserted into bottom hem.

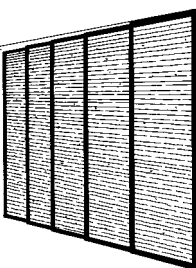
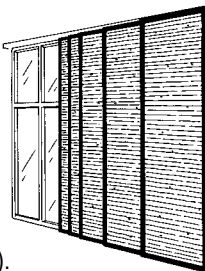

Size Standards

See Specification Summary on [page 9](#).

- Maximum track width is 144":
 - For windows greater than 144" wide, tracks may be butted but panels will not meet.
- Cord Draw is available up to 108" length
- Wand Control is available up to 96" length;
 - Shades less than 7' long have a 36" wand
 - Shades 7' or greater have a 48" wand
- Minimum height of shade is 24" for cord draw
- Minimum height of shade is 39" for wand draw

Important Child Safety Note

The revised American National Standard for Safety of Corded Window Covering products requires if corded window products are used in the home, cord cleats or cord tension locks must be properly installed.

Hardware Included

- Installation Brackets
- Cord Tensioner Bracket with Cord Draw

Options

- No Charge
 - 3" Twill Banding
 - Back Draw Panel - Panels stack in back of each other with the fixed panel closest to the ROOM side
 - Wand Control - Wand Control with Split Draw has 2 wands;
 - Wand is clear acrylic
 - Wand Length (36" or 48")
- Surcharge
 - 1 1/4" Fabric Banding
 - 3" Fabric Banding
 - Lining (Based on lining type)

Ordering Notes

- Exclusions: Fabrics shown as N/A on [page 3](#).
- For windows wider than 144", the tracks may be butted but the panels will not meet.
- Deduct 1/2" for floor clearance on ceiling mount installation.

Caution

- Manh Truc materials are made from **natural materials and will have visible imperfections**. Some natural patterns offer slight differences in grain and texture, especially in materials containing knots or slight surface cracks. The finest native materials in shades contain some variations in color and hue. In addition, natural materials can have a slight bow or camber so that horizontal lines or bottom hems might not be perfectly straight. Fold alignment can vary slightly, even on shades that are the same height. Shades made of natural materials tend to stretch slightly over time.

Mounting Requirements

- Inside Mount (IS)
 - Minimum Mounting Depth
 - 3 Channels: 1 7/8"
 - 4 Channels: 2 1/4"
 - 5 Channels: 3"
 - Minimum Mounting Depth, flush mount
 - 3 Channels: 1 15/16"
 - 4 Channels: 2 5/8"
 - 5 Channels: 3 3/8"
- Outside Mount (OS)
 - Minimum Flat Vertical Surface: 5/8"



Finished Dimensions

- Inside Mount (IS)
 - Overall Fabric Width - Cord Draw: - 1" (1/2" on each side)
 - Overall Fabric Width - Wand Draw: - 1/4"
 - Shade Height: -3/8"
- Outside Mount (OS)
 - Overall Fabric Width: Ordered Width
 - Shade Height: Ordered Height
 - Track Width for Cord Draw: Ordered width + 1"
 - Track Width for Wand Draw: Ordered width + 1/4"

Approximate Panel Size

See table on [page 34](#) for approximate panel size.

Product Information

Manh Truc Panel Track Configurations

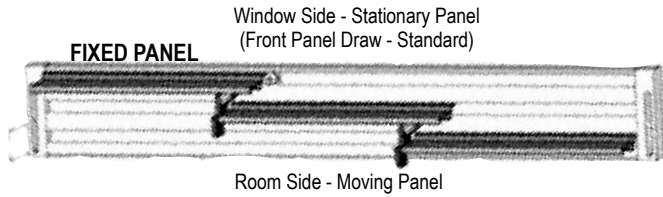

- 3 Channels - One Way Draw
 2 Panels
 For 2 panel systems one channel is empty
 2 Panels - Minimum Track Width is 27"
 2 Panels - Maximum Track Width is 79"
 Number of Overlaps: 1
 3 Panels
 3 Panels - Minimum Track Width is 39"
 3 Panels - Maximum Track Width is 117"
 Number of Overlaps: 2

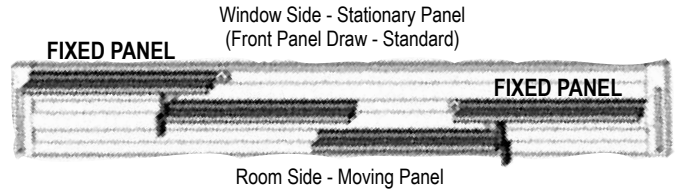

- 3 Channels - Split Draw - Wand Control
 4 Panels
 Minimum Track Width is 51"
 Maximum Track Width is 144"
 Number of Overlaps: 3

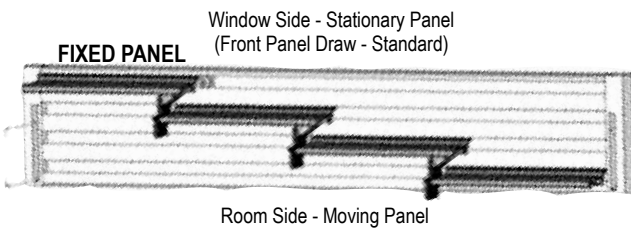

- 4 Channels - One Way Draw
 4 Panels
 Minimum Track Width is 51"
 Maximum Track Width is 144"
 Number of Overlaps: 3

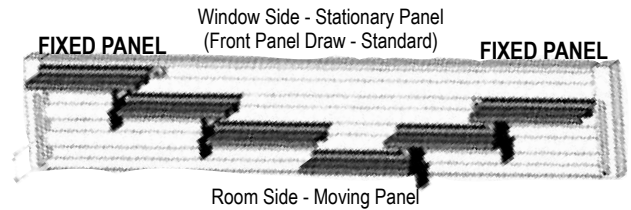

- 4 Channels - Split Draw - Wand Control
 6 Panels
 Minimum Track Width is 75"
 Maximum Track Width is 144"
 Number of Overlaps: 5

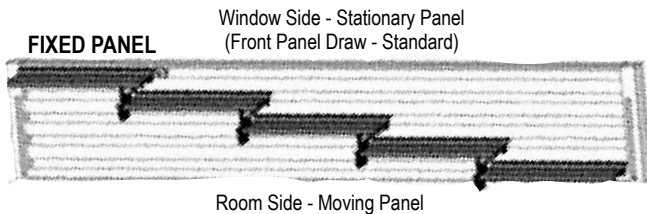

- 5 Channels - One Way Draw
 5 Panels
 Minimum Track Width is 63"
 Maximum Track Width is 144"
 Number of Overlaps: 4

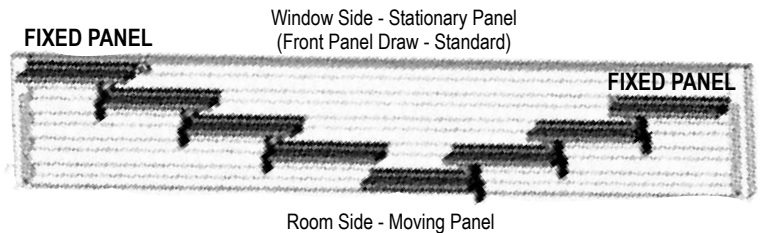

- 5 Channels - Split Draw - Wand or Cord Control
 All Split Draw with Cord Control utilize a 5 Channel track
 8 Panels
 Minimum Track Width is 99"
 Maximum Track Width is 144"
 Number of Overlaps: 7

Product Information

Manh Truc Panel Track

Approximate Panel Size Tables based upon Panels and Overlaps

Panel Width cannot be specified.

Panel Sizes given are approximate and based upon Outside Measure/Mount

2 Panels / 1 Overlap

Panel Min.	Panel Max.	Window Min.	Window Max.
15"	16"	27"	29"
16 1/16"	17"	29 1/8"	31"
17 1/16"	18"	31 1/8"	33"
18 1/16"	19"	33 1/8"	35"
19 1/16"	20"	35 1/8"	37"
20 1/16"	21"	37 1/8"	39"
21 1/16"	22"	39 1/8"	41"
22 1/16"	23"	41 1/8"	43"
23 1/16"	24"	43 1/8"	45"
24 1/16"	25"	45 1/8"	47"
25 1/16"	26"	47 1/8"	49"
26 1/16"	27"	49 1/8"	51"
27 1/16"	28"	51 1/8"	53"
28 1/16"	29"	53 1/8"	55"
29 1/16"	30"	55 1/8"	57"
30 1/16"	31"	57 1/8"	59"
31 1/16"	32"	59 1/8"	61"
32 1/16"	33"	61 1/8"	63"
33 1/16"	34"	63 1/8"	65"
34 1/16"	35"	65 1/8"	67"
35 1/16"	36"	67 1/8"	69"
36 1/16"	37"	69 1/8"	71"
37 1/16"	38"	71 1/8"	73"
38 1/16"	39"	73 1/8"	75"
39 1/16"	40"	75 1/8"	77"
40 1/16"	41"	77 1/8"	79"

4 Panels / 3 Overlaps

Panel Min.	Panel Max.	Window Min.	Window Max.
15"	16"	51"	55"
16 1/16"	17"	55 1/8"	59"
17 1/16"	18"	59 1/8"	63"
18 1/16"	19"	63 1/8"	67"
19 1/16"	20"	67 1/8"	71"
20 1/16"	21"	71 1/8"	75"
21 1/16"	22"	75 1/8"	79"
22 1/16"	23"	79 1/8"	83"
23 1/16"	24"	83 1/8"	87"
24 1/16"	25"	87 1/8"	91"
25 1/16"	26"	91 1/8"	95"
26 1/16"	27"	95 1/8"	99"
27 1/16"	28"	99 1/8"	103"
28 1/16"	29"	103 1/8"	107"
29 1/16"	30"	107 1/8"	111"
30 1/16"	31"	111 1/8"	115"
31 1/16"	32"	115 1/8"	119"
32 1/16"	33"	119 1/8"	123"
33 1/16"	34"	123 1/8"	127"
34 1/16"	35"	127 1/8"	131"
35 1/16"	36"	131 1/8"	135"
36 1/16"	37"	135 1/8"	139"
37 1/16"	38"	139 1/8"	143"
38 1/16"	39"	143 1/8"	147"
39 1/16"	40"	147 1/8"	151"
40 1/16"	41"	151 1/8"	155"

6 Panels / 5 Overlaps

Split Draw Only			
Panel Min.	Panel Max.	Window Min.	Window Max.
15"	16"	75"	81"
16 1/16"	17"	81 1/4"	87"
17 1/16"	18"	87 1/4"	93"
18 1/16"	19"	93 1/4"	99"
19 1/16"	20"	99 1/4"	105"
20 1/16"	21"	105 1/4"	111"
21 1/16"	22"	111 1/4"	117"
22 1/16"	23"	117 1/4"	123"
23 1/16"	24"	123 1/4"	129"
24 1/16"	25"	129 1/4"	135"
25 1/16"	26"	135 1/4"	141"
26 1/16"	27"	141 1/4"	147"
27 1/16"	28"	147 1/4"	153"
28 1/16"	29"	153 1/4"	159"
29 1/16"	30"	159 1/4"	165"
30 1/16"	31"	165 1/4"	171"
31 1/16"	32"	171 1/4"	177"
32 1/16"	33"	177 1/4"	183"
33 1/16"	34"	183 1/4"	189"
34 1/16"	35"	189 1/4"	192"

3 Panels / 2 Overlaps

Panel Min.	Panel Max.	Window Min.	Window Max.
15"	16"	39"	42"
16 1/16"	17"	42 1/8"	45"
17 1/16"	18"	45 1/8"	48"
18 1/16"	19"	48 1/8"	51"
19 1/16"	20"	51 1/8"	54"
20 1/16"	21"	54 1/8"	57"
21 1/16"	22"	57 1/8"	60"
22 1/16"	23"	60 1/8"	63"
23 1/16"	24"	63 1/8"	66"
24 1/16"	25"	66 1/8"	69"
25 1/16"	26"	69 1/8"	72"
26 1/16"	27"	72 1/8"	75"
27 1/16"	28"	75 1/8"	78"
28 1/16"	29"	78 1/8"	81"
29 1/16"	30"	81 1/8"	84"
30 1/16"	31"	84 1/8"	87"
31 1/16"	32"	87 1/8"	90"
32 1/16"	33"	90 1/8"	93"
33 1/16"	34"	93 1/8"	96"
34 1/16"	35"	96 1/8"	99"
35 1/16"	36"	99 1/8"	102"
36 1/16"	37"	102 1/8"	105"
37 1/16"	38"	105 1/8"	108"
38 1/16"	39"	108 1/8"	111"
39 1/16"	40"	111 1/8"	114"
40 1/16"	41"	114 1/8"	117"

5 Panels / 4 Overlaps

Panel Min.	Panel Max.	Window Min.	Window Max.
15"	16"	63"	68"
16 1/16"	17"	68 1/8"	73"
17 1/16"	18"	73 1/8"	78"
18 1/16"	19"	78 1/8"	83"
19 1/16"	20"	83 1/8"	88"
20 1/16"	21"	88 1/8"	93"
21 1/16"	22"	93 1/8"	98"
22 1/16"	23"	98 1/8"	103"
23 1/16"	24"	103 1/8"	108"
24 1/16"	25"	108 1/8"	113"
25 1/16"	26"	113 1/8"	118"
26 1/16"	27"	118 1/8"	123"
27 1/16"	28"	123 1/8"	128"
28 1/16"	29"	128 1/8"	133"
29 1/16"	30"	133 1/8"	138"
30 1/16"	31"	138 1/8"	143"
31 1/16"	32"	143 1/8"	148"
32 1/16"	33"	148 1/8"	153"
33 1/16"	34"	153 1/8"	158"
34 1/16"	35"	158 1/8"	163"
35 1/16"	36"	163 1/8"	168"
36 1/16"	37"	168 1/8"	173"
37 1/16"	38"	173 1/8"	178"
38 1/16"	39"	178 1/8"	183"
39 1/16"	40"	183 1/8"	188"
40 1/16"	41"	188 1/8"	192"

8 Panels / 7 Overlaps

Split Draw Only			
Panel Min.	Panel Max.	Window Min.	Window Max.
15"	16"	99"	107"
16 1/16"	17"	107 1/4"	115"
17 1/16"	18"	115 1/4"	123"
18 1/16"	19"	123 1/4"	131"
19 1/16"	20"	131 1/4"	139"
20 1/16"	21"	139 1/4"	147"
21 1/16"	22"	147 1/4"	155"
22 1/16"	23"	155 1/4"	163"
23 1/16"	24"	163 1/4"	171"
24 1/16"	25"	171 1/4"	179"
25 1/16"	26"	179 1/4"	187"
26 1/16"	27"	187 1/4"	192"

One Way Stacking Width = Panel Width

Split Draw Stacking Width = Panel Width x 2

Product Information

Manh Truc Panel Drape

Product Features

- Fits rectangular window openings.
- Available on many Manh Truc fabrics; See [page 3](#).
- Panel Drape material is RAILROADED (turned sideways) - see picture below.
- One Way Draw. A locking pin provides a stationary end.
- Fabric Banding (1" showing) across the top.
- Select fabric banding from one of twelve fabric colors.
- Approximately 1.5x's Fullness.
- Leading Edge provides a means for traversing the drape. Select the wood edging color from any one of the eight colors from the wood valance collection: Buckeye, Cottage Pine, Ebony Wash, Gardenia, Java Roast, Mahogany, Natural, Navajo White. Color Thunder is also available - see Heartland Woods sample book or the Materials Library.
- The UniFold™ bead spacing system maintains uniform spacing of folds as you slide your Panel Drape open and closed. Bead is color coordinated in white or brown.
- Panel Drape stacks to approx. 15% of total track width.
- Brown, White or Gray Hand Traverse Track. Gray and white track have white carriers. Brown track has brown carriers.
- Track system is 1/2" high and 5/8" deep extruded aluminum.
- Track can be ceiling mounted or wall mounted.

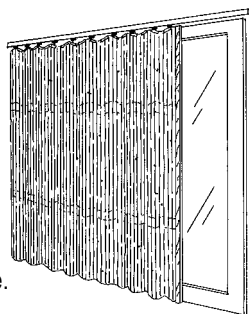

Carrier Attachment

Size Standards

- See Specification Summary on [page 9](#).
- Maximum track width is 120"
 - Minimum height of shade is 24".
 - Maximum shade height varies by fabric.

Hardware Included

- Installation Brackets

Options

- No Charge
 - Knobs on wood edge: 3/4" Brass, Antique Brass or Nickel
 - Panels Only with carriers attached - No track. Select carrier color (white or brown).
- Surcharge
 - 2" Decorative Wood Pole and Ball Finial or End Cap. OS Mount only. See [page 40](#) for further information.



- Split Draw with recessed magnets on wooden rails
- Lining (Based on lining type)
- Bottom Hem Banding:
 - 3" Fabric Banding (1 1/2" showing)
 - N/A on some fabrics - see [page 3](#)
- Straight or Railroaded Cornice



Ordering Notes

- Sahara Channel Track (H Rail) can be ordered separately. See [page 40](#) for further information.



Sahara Channel Track with Sahara Finial

- Exclusions: Fabrics shown as N/A on [page 3](#).
- For windows wider than 120", the tracks may be butted and the panels will not meet.
- Lining length is 1/2" less than Panel Drape length.
- Deduct 1/2" for floor clearance on ceiling mount installation.

Caution

- Manh Truc materials are made from **natural materials and will have visible imperfections**. Some natural patterns offer slight differences in grain and texture, especially in materials containing knots or slight surface cracks. The finest native materials in shades contain some variations in color and hue.

Mounting Requirements

- Inside Mount (IS)
 - Minimum Mounting Depth: 1"
 - Mounting Depth, flush mount: 1 1/2"
- Outside Mount (OS)
 - Minimum Flat Vertical Surface: 1 1/2"



Panel Drape material orientation (RAILROADED)

Finished Dimensions

- Inside Mount (IS)
 - Overall Fabric Width: - 1/8"
 - Shade Height: - 3/8"
- Outside Mount (OS)
 - Overall Fabric Width: Ordered Width
 - Shade Height: - 3/8"
 - Track Width: Ordered Width



Roman/Roller Shade material orientation

Product Information

Manh Truc Stationary Grommet Panels

Product Features

- Fits rectangular window openings.
- Available on many Manh Truc fabrics; See [page 3](#).
- Grommet Panel material is RAILROADED (turned sideways) - see picture below. Panel length cannot exceed fabric width.
- Approximately 2x's Fullness
- 3 1/2" Returns
- 3" Fabric Banding showing on the top of the Grommet Panel.
- 1 1/2" Fabric Banding showing on the panel sides.
- Grommets are 2 1/8" OS diameter and fit up to a 1 3/8" diameter rod or pole.
- Choose from one of six grommet colors: Matte Nickel, Antique Brass, Antique Copper, Black, Satin Smoke, or Oil Rubbed Bronze.



Inside Diameter: 1 1/2"
Outside Diameter: 2 1/8"



Woven Shade material orientation



Grommet Panel material orientation (RAILROADED)

Hardware - None Included

Options

- Surcharge
- Bottom Hem Banding: 3" Fabric Banding with 1 1/2" band showing
N/A on some fabrics - See [page 3](#)
- Lining (Based on lining type)

Ordering Notes

- Pricing is PER PANEL.
- Rod or pole is purchased separately. Refer to Lafayette Drapery Hardware or Kirsch Drapery Hardware price list.
- Exclusions: Fabrics shown as N/A on [page 3](#).
- Lining length is 1/2" less than Panel length.

Caution

- Non-functioning panel - designed to be used as a stationary panel only.
- Manh Truc materials are made from **natural materials and will have visible imperfections**. Some natural patterns offer slight differences in grain and texture, especially in materials containing knots or slight surface cracks. The finest native materials in shades contain some variations in color and hue. In addition, natural materials can have a slight bow or camber so that horizontal lines or bottom hems might not be perfectly straight. Fold alignment can vary slightly, even on shades that are the same height. Shades made of natural materials tend to stretch slightly over time.

Finished Dimensions

- Panel Width: See below
- Panel Height: Ordered Height

Size Standards

- 3 sizes of panel available:
 - 6 Grommets (32" flat width)
 - 8 Grommets (42" flat width)
 - 12 Grommets (62" flat width)
- Maximum height of Grommet Panel is 94" (exception: Kaila 70")
- Minimum height of panel is 24"



6 Grommets



8 Grommets



12 Grommets

Product Information

Manh Truc Design Options - Child Safety



TLC Roman Shade Child Safe Cord Sleeve

- Child safety design standard on all Manh Truc Roman Shades.
- Our TLC child safe cord sleeve completely encloses the rear traveling lift cords inside a protective sleeve. The sleeve is anchored every seven inches along the back of the shade to confine the cord and eliminate the possibility of dangerous cord loops.
- Protective sleeve available in natural, camel, bronze, and gray.
- Operates on lined or unlined roman shades.
- Lafayette's TLC cord sleeve has been tested by a Consumer Products Safety Commission (CPSC) approved independent laboratory and passed the provisions cited in the American National Standards Institute (ANSI/WCMA A100.1-2010).

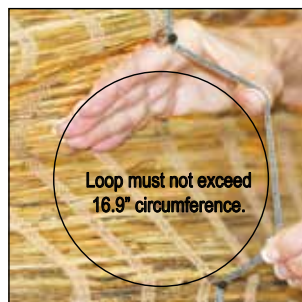
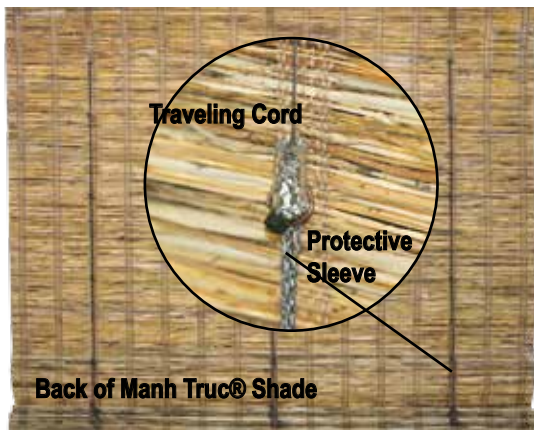

CareRING Cordless Lift System

- Unique cordless child safety design available on most Manh Truc Flat Roman Shades and some unlined Hobbled Roman Shades. See [page 4](#) for fabric availability.
- See [page 6 and 7](#) for size availability.
- Traditional Style: Inside mount shade has a 7" long self-valance to the front, returns can be requested.
- Contemporary Style: Inside mount shade has no returns with a 7" long back valance standard. Outside mount shade has 7" long returns and an optional 7" back valance by request at time of order.
- CareRING and stop ball are anodized aluminum finish and are attached to the back of the cordless shade.
- Not available with banding or clutch system; Not available for fabrics that require banding.
- Not available as a lined Hobbled Shade, Top Down/Bottom Up, Duo-Shade, Turned Headrail, Multiple Shades on One Headrail or any specialty shape shade.
- For inside mount, 3" screws are included.
- For outside mount, L brackets are included.
- CAUTION: Do not over-rotate or shade does not roll up.
- Operation: Raise or lower the shade by pulling on the CareRING not the bottom of the shade.

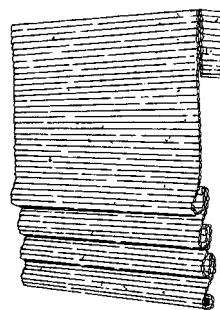

CareRING Cordless Shade Front

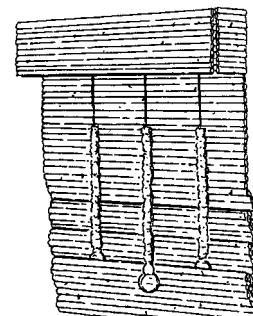

CareRING Cordless Shade Back



CareRING Cordless Shade Raised

Cord Tension Lock for Clutch Shades

- Standard on all Manh Truc Shades with a clutch system.
- The Cord Tension Lock must be secured to the wall to provide the necessary tension for the shade to operate.
- The Cord Tension Lock is available in vanilla or brown and is coordinated to shade color.
- Clutch Continuous Loop system will be inoperable if the Cord Tension Lock is not secured.
- Cord Tension Lock is an additional precaution designed to protect children and pets.

The horizontal lines on the Cord Tension Lock show where the screw should be tensioned. If the tensioner is not set at the level suggested, the tension will be too tight and the cord may break.



Cord Cleat for Lift Cord Shades

- Sent with each Manh Truc shade with a lift cord.
- The Cord Cleat should be attached to the wall to wrap and secure lift cords.
- The Cord Cleat is a clear plastic.
- Cord Cleat is considered a child safety device and should be addressed with consumer when it is installed.

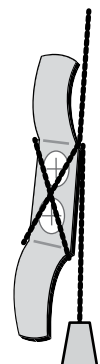

Product Information

Manh Truc Design Options - Edge Banding

Flat or Hobbled Roman Shade Edge Banding

- Edge Banding is wrapped around the edges of the shade or valance and sewn in place.
- Four edge banding styles are available:
 - 1 1/4" width twill banding in 13 solid colors
(5/8" of banding shows on front and back of shade)
 - 3" width twill banding in 13 solid colors
(1 1/2" of banding shows on front and back of shade)
 - 1 1/4" width fabric banding in 12 solid colors
(5/8" of banding shows on front and back of shade)
 - 3" width fabric banding in 12 solid colors
(1 1/2" of banding shows on front and back of shade)
- Banding is REQUIRED on patterns Bengali, Khan, Lada, Malana and Malie - Add banding surcharge to shade price.
- Refer to [page 3](#) for Edge Banding availability.
- Edge Banding can be combined with the lining option.
- Vertical banding will overlap horizontal banding at the corners.
- If a bottom hem is banded it has 3" banding to cover the weight bar inserted into the hem.
- For multiple shades on one headrail, add banding surcharge for each shade. (Ex: For 3 on 1 headrail, add 3 banding surcharges.)
- For multiple shades on one headrail, the banding on the valance will not align vertically with the banding on the adjacent shade due to the 1/2" gap between the shades.
- Select banding color from the Twill Banding Sample Card and Fabric Banding Sample Card in the sample book.
- Six banding configurations are available:



Self-Valance Hem/Bottom Hem - VBH2
(3" banding on all Bottom Hems to cover weight bar inserted in hem)



Self-Valance Sides/Shade Sides - VSS2

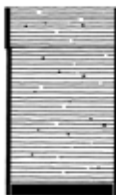

Sides/Bottom Hem - SBH3
(Shown: Bottom hem has 3" banding to cover weight bar inserted in hem even though shade has 1 1/4" banding)



Both Sides and Hems - BSH4
(Bottom hem has 3" banding to cover weight bar inserted in hem)



Valance/Cornice Only Sides - VOS2



Valance/Cornice Only Sides and Hem - VOB3
(Not available in a Hobbled Cornice)

Roller Shade Edge Banding

- Edge Banding is not available on Manh Truc Roller Shades.

Panel Track Edge Banding

- Edge Banding is wrapped around the edges of each panel and sewn in place.
- The 1 1/4" Twill Banding with a 3" Twill on Bottom Hem is included in the Panel Track price.
- All Panel Track Bottom Hems will be made with 3" banding to cover the weight bar.
- 3" Twill Banding is available at no charge.
- 1 1/4" or 3" Fabric Banding are available for a surcharge.
- Edge banding styles available:
 - 1 1/4" width twill banding in 13 solid colors
(5/8" of banding shows on front and back of shade)
 - 3" width twill banding in 13 solid colors
(1 1/2" of banding shows on front and back of shade)
 - 1 1/4" width fabric banding in 12 solid colors
(5/8" of banding shows on front and back of shade)
 - 3" width fabric banding in 12 solid colors
(1 1/2" of banding shows on front and back of shade)
- Vertical banding will overlap horizontal banding at the corners.
- Select banding color from the Twill Banding Sample Card or Fabric Banding Sample Card in the sample book.

Panel Drape Banding

- 1 1/2" Fabric Banding showing on the top edge of the Panel Drape is standard. Select the Fabric Banding color.
- 1 1/2" Fabric Banding showing can be added to the bottom edge of the Panel Drape for a surcharge for most fabrics. See [page 3](#) for fabric availability.

Grommet Panel Banding

- 3" Fabric Banding showing on the top edge of the Grommet Panel is standard. Select the Fabric Banding color.
- 1 1/2" Fabric Banding showing on the vertical edges of the Grommet Panel is standard. Banding color matches top banding.
- 1 1/2" Fabric Banding showing can be added to the bottom edge of the Grommet Panel for a surcharge for most fabrics. See [page 3](#) for fabric availability.



For all banding -
Sewing standard with Vertical Banding overlapping the Horizontal Banding



Notes:
The Edge Banding will show on the bottom hem even when the shade is in the raised position.

On a Hobbled Shade, the fold is enhanced with edge banding and will form a billow.

Product Information

Manh Truc Design Options

Multiple Shades on One Headrail

- Available on Flat and Hobbled Roman shades in both Traditional or Contemporary style.
- Two or three shades which share the same headrail. Shades have a 1/2" gap.
- For 2 on 1 Headrail - when valance width exceeds material width the valance is split in the center and butted together.
- For 3 on 1 Headrail - when valance width exceeds material width the valance follows the shade configuration.
- Each shade operates independently.
- Cords are to outside edge of shade unless otherwise specified; for three-on-one headrail, center shade has cords on right.
- Shades are patterned to match valance.
- **Horizontal pattern alignment is *not* guaranteed.**
- Size limitations: maximum overall width is 144";
- Designate overall area to be covered and the width of each shade, allowing 1/2" between shades for operation.
Example of two-on-one (outside measure):
If each shade is 45" then overall width is 90 1/2" (45+1/2+45).
Example of three-on-one (outside measure):
If each shade is 40" then overall width is 121" (40+1/2+40+1/2+40).
For inside measure: Lafayette will deduct 1/2" from the overall width of the shade.
- The total width of all shades plus allowances must equal overall width.
- Price shade by the overall width and add the two-on-one or three-on-one surcharge.
- Price lining option for multiple shades on one headrail for EACH SHADE.

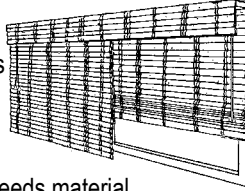

Top Down/Bottom Up Shade

- Shade forms accordion folds when raised or lowered.
- Shade lowers from the top and raises from the bottom; two sets of cords and cord locks.
- Right cord raises and lowers top of shade; left cord raises and lowers bottom of shade.
- Valance and cord lift system with cord to the front of the shade.
- Shade has a 7" long self-valance for both front and back of the shade to conceal hardware.
- **Cords are visible when shade is lowered from the top.**
- Not available with CareRING Cordless, Clutch System or Multiple Shades on One Headrail.
- Refer to [page 3](#) for Edge Banding availability.
- Lining option is available however the shade must also have edge banding. Add both lining and edge banding surcharge.
- For inside mount, 3" screws are included.
- For outside mount, structured returns are standard; wrapped ends can be requested at no charge.
- Size limitations: Minimum width 24"; Maximum width varies by shade material (see [page 5](#)); Maximum length 108"

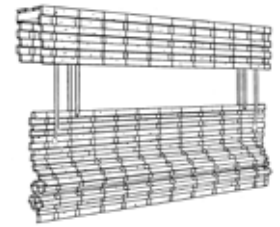

Turned Headrail

- Projection is 1". Only available with Cordlock system. The 2" board is turned on its edge and hardware is installed. The turned headrail allows the shades to be installed in shallow window openings and also provides a low profile installation on doors.

Bead Chain Options

- Available on a clutch operated roman shade.
- Bead chain colors are White, Vanilla, Black, Brown, Sierra Tan, and Gray. Bead chain is color coordinated to the shade color.
- Bead chain lengths are 12", 18", 24", 36", 48", 60", 72", 84" and 96".
- Bead chain lengths must be at least 6" shorter than window length for inside mounts to properly install tensioner.
- Metal Bead Chain in Stainless Steel, Antique Bronze, Gun Metal or Burnished Copper are available for a surcharge.

Lining

- Available on Flat Roman shades, Panel Track and Panel Drape.
- Shade and self-valance are lined with high quality polyester/cotton lining.
- Light Filtering lining is available in six colors: Coffee Bean, Gold Dust, Iceberg, Midnight, Silver, and Snowflake.
- Opaque lining is available in six colors: Birch, Buff, Cream, Ebony, Slate and Snow.
- Opaque linings have darker color to the shade side and white to the street side.
- Opaque lining will block 98% of the light if the shade is installed properly.
- Areas of light are visible through ring holes.
- Can be combined with edge banding option.
- Available for Angle Top, Arch Top and Arch shades. If a lined Angle Top or Arch Top shade is ordered, the lining extends into the arch or angle.
- The self-valance is also lined when a lined shade is ordered; valance lining can be ordered on an unlined shade.
- Lining is inset approximately 1/4" to 1/2" from the edge of the woven material on each side.
- For multiple shades on one headrail, add lining surcharge for each shade. (Ex: For 3 on 1 headrail, add 3 lining surcharges.)
- Shade lining may need to be "dressed", especially when ordering bulky patterns or shades over 50" wide or long. This dressing step helps to train the lining to fall into the folds.
- For a separate woven shade and liner shade, see Duo Shade information on [page 27](#).

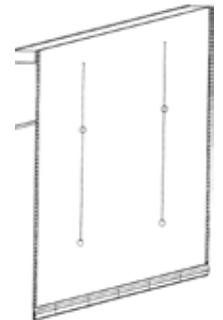

Product Information

Manh Truc Design Options - Valances & Track Options

Manh Truc Roman Shade Self-Valance

- A 7" long flat self-valance is standard with each Flat Roman and Hobbled Roman woven shade. If the Flat Roman Shade is lined, then the accompanying self-valance is lined.
- See specification pages for standard return based on shade style and inside/outside mount designation.
- Soft Returns are an option on IS or OS mount shades.
- Self-valance for an unlined shade can be lined; Use lining surcharge multiplied by .30.
- Self-valances longer than 7" and up to 36" can be specified for a surcharge per 12" increment.
- For 2 on 1 Headrail - when valance width exceeds material width the valance is split in the center and butted together.
- For 3 on 1 Headrail - when valance width exceeds material width the valance follows the shade configuration.
- Edge Banding is available on shade self-valance. Refer to [page 3](#) for edge banding availability and [page 38](#) for edge banding configurations..
- Gimp trim is available on the valance hem for a surcharge.



Structured Return



Wrapped End



Soft Return

Panel Drape - Decorative Wood Poles

- This can only be ordered for an Outside Mount Panel Drape.
- 2" Smooth Decorative Wood Pole is finished and routed for track insertion.
- Select one of eight paint or stain finishes from the wood valance collection: Buckeye, Cottage Pine, Ebony Wash Gardenia, Java Roast Mahogany, Natural, Navajo White. Color Thunder is also available - see Heartland Woods sample book or the online Materials Library.
- Select either the Ball Finial or End Cap to be finished in the same finish selected for the Decorative Wood Pole.
- Standard return from back of pole to wall is 3 1/2".
- Maximum pole width is 120".
- Wood End Brackets and brass support brackets are included for installation.
- Pole is 3" greater than the ordered width.
- Caution: Due to varying wood grains the pole, bracket, and finials will not be an exact match.



Ball Finial



End Cap



Wood Installation Bracket

Board Mounted Waterfall Valance

- Woven shade material cascades over the 2" x 1" headrail to create a layered look.
- Turned headrail is available at no charge.
- Refer to [page 5](#) for availability and sizes.
- Not available with Lining or Edge Banding.
- Maximum valance width is the material width.
- Standard valance length is 6" for top cascade of the valance and 12" for the bottom cascade of the valance. Additional front and/or back length can be ordered using "Addtl 12" Valance" surcharge.
- Woven shade straight trim surcharge includes gimp from Embellishments (up to a RETAIL price of \$6.00/yard). If two rows of trim are ordered then the Straight Trim surcharged is multiplied by two. Other trim can be selected from Embellishments and the trim is invoiced per yard.

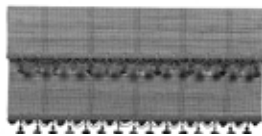

Shown with two rows of Embellishments Trim)

Panel Drape with No Track

- Carriers are attached to Panel Drape.
- Select carrier color: White or Brown.

Ordering Notes for Sahara Channel Track

- A Sahara Mechanical Channel Track can be ordered separately.
- Panels will come ordered width and height.
- Order Sahara channel track width 1 1/2" greater than Panel Drape ordered width.
- Select Sahara pole color, brackets (WI-16XXX), and finials.
- See the Lafayette Drapery Hardware price list at www.lafayetteinteriorfashions.com/Dealer Center for Sahara Channel Track pricing.
- [Click here to see the Sahara Channel Track, bracket and finial sell sheets.](#)

Majesty, Noble 4 5/8", or Camelot Wood Valance

- For Panel Track or Panel Drape - not recommended for roman shades.
- Standard return is 6" from back of valance to wall.
- Valances are available in 14 colors: Accessible Beige, Buckeye, Cottage Pine, Ebony Wash, Gardenia, Harmony, Java Roast, Mahogany, Moonshine, Natural, Navajo White, Revere Pewter, Snow White, Thunder. Sample chips are available using MySwatch.
- If wood valance is over 96" the valance will be spliced. Maximum spliced width is 132".

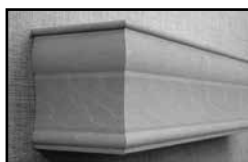

Majesty Valance
4 1/2" height
5/8" deep



Noble Valance
4 5/8" height
1/2" thick

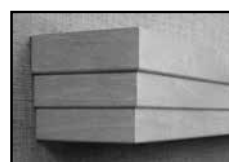

Camelot Valance
3 1/2" height
1/2" deep

Product Information

Manh Truc Design Options - Cornices

Straight or Railroaded Cornice

- A stand-alone 7" long cornice ordered separately.
- Available with 2", 3 1/2" or 5 1/2" returns.
- Straight Cornice has cornice material running in same direction as the woven shade or Panel Track.
- Straight Cornice has cornice material running perpendicular to the Panel Drape.
- Manh Truc Straight Cornice includes fabric covering top of board and legs.
- Maximum Straight Cornice width is 120". If the cornice width is greater than the shade material, the cornice is split into two equal widths.
- Railroaded Cornice has cornice material perpendicular to the woven shade or Panel Track.
- Manh Truc Railroaded Cornice board is painted or stained to coordinate with the fabric.
- Maximum Railroaded Cornice width is 120".
- Additional length can be added by using the "Addtl 12" Valance" surcharge price.
- Available lined; Use lining surcharge multiplied by .30.
- For a Straight Cornice, Ties or Knotted Ties using Fabric Banding are available. If Ties or Knotted Ties are desired on the cornice, add the Ties surcharge to the Cornice surcharge.

Ordering Notes

- If cornice is being ordered separately to go over a shade, order the cornice 2" wider than shade width to allow for side leg boards.

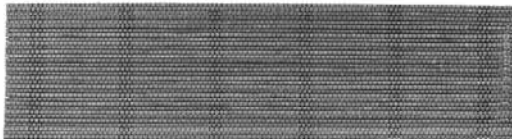

Straight Cornice

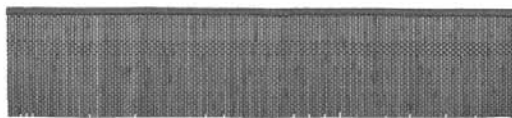

Railroaded Cornice

Hobbled Cornice

- Two 6" hobbled folds form a 12" long cornice, order separately.
- Manh Truc Hobbled Cornice includes fabric covering the top of board and legs.
- Maximum hobbled cornice width is equal to the material width. See [page 5](#) for specifications.
- Available with 2", 3 1/2" or 5 1/2" returns.
- Not available with Lining.
- Edge Banding is on cornice face side edges only (VOS2). Refer to page 3 for availability.
- Ties are Twill Banding or Fabric Banding. Knotted Ties with Tails are Fabric Banding only. For Ties or Knotted Ties with Tails, add the Ties surcharge to the cornice surcharge.

Ordering Notes

- For Panel Track - order a 3 1/2" return for 3 channels or 5 1/2" return for 4 or 5 channels.
- If cornice is going over a shade, order cornice 2" wider than shade width due to side leg boards.

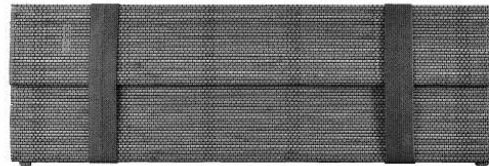

Hobbled Cornice

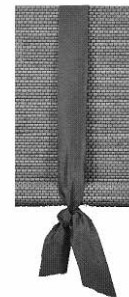

Knotted Ties with Tails
Tails hang approx. 6"

Product Information

Manh Truc Design Options - Miscellaneous

Manh Truc Wood Bottom Hem

- Available for Manh Truc Flat Roman and Hobbled Roman Shades.
- Wood Bottom Hem is 2" high x 5/8" deep.
- Most Manh Truc materials can be inserted into the Wood Bottom Hem. See [page 5](#) for Wood Bottom Hem availability by pattern.
- Maximum shade width using a wood bottom hem is 72".
- Wood Bottom Hem is available in eight colors: Buckeye, Cottage Pine, Ebony Wash, Gardenia, Java Roast, Mahogany, Natural, Navajo White. Color Thunder is also available - see Heartland Woods sample book or the online Materials Library.
- For multiple shades on one headrail, add hem surcharge for each shade. (Ex: For 3 on 1 headrail, add 3 wood bottom hem surcharges.)



Manh Truc Straight Trim

- Available for Manh Truc Flat Roman Shades, Hobbled Roman Shades and Roller Shades.
- Trim is applied to the straight bottom edge of either the valance hem or the shade hem.
- Indicate trim style/color item number and placement. The surcharge for trim is a surcharge per row. If straight trim is desired on BOTH the valance and the shade bottom then multiply the surcharge by 2.
- Woven shade trim surcharge includes gimp available from Embellishments collection up to a RETAIL price of \$6.00/yd. Other trim can be selected from Embellishments and the trim is invoiced on a per yard basis.



P Clip Safety Tensioner

- An option in place of a cord tensioner. The clear P-Clip has a torsion spring that will open the tensioner and prevents the chain from sliding through it. The tensioner will then render the shade partially inoperable if it is loose from the wall.



Palladian Window Shelf

- Double beaded hardwood shelf designed to mount horizontally in arched or angled openings to serve as a divider and mounting surface.
- Allows area above shelf to be covered differently or uncovered.
- Finishes available from Woodland Harvest or Heartland Woods; also available unfinished.
- 1/32" per foot tolerance for warpage.
- Inside Mount Applications only.
- Dimensions
 - Height: 1 1/2"
 - Depth: 4" (Can cut down to 2")
 - Maximum Length: 8'
- Must be installed below the radius of window as routed ends are square.
- Specify exact width from jamb to jamb. A 1/16" deduction is taken.
- Ordered separate from shade (Priced by lineal foot - round up).

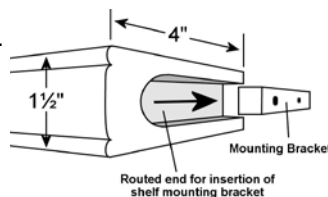

Mitered Corners

- A **template** is required with dimensions A, B, C, D, and E indicated to determine the miter angle.
- Available for Manh Truc Flat Roman Shades.
- Two adjoining shades can be mitered for corner or bay windows.
- **Mitered shades cannot be raised to the same height level; mitered shades will not fully raise due to the folds.**
- Not available on Hobbled Shades, Turned headrail or clutch system.
- Banding and lining options are based on the shade material selected.
- Lift cords are mounted opposite the miter for corner windows; for bay windows, center shade has cords on right.
- **Horizontal pattern alignment is *not* guaranteed.**

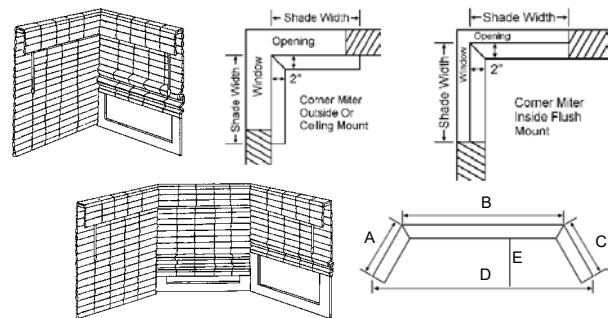

Manh Truc Shutters

- Complete any room using coordinating Manh Truc Woven Shades and Woodland Harvest Shutters.
- See [page 9](#) for Manh Truc Shutter availability.
- Manh Truc Plantation Shutters and Privacy Screens are priced in the Woodland Harvest Retail Sales Guide.



Hold Down Option

- Available for most shade styles; see [page 10](#) for availability.
- An oval wooden rod with a pre-drilled hole on each end is rolled into the bottom of the shade. The hold down bracket has a pin to hold the oval rod in place.
- Hold downs must be specified at the time of the order as the oval rod cannot be retrofitted in the field.
- **Important: The hold down option will affect the thickness of the bottom hem.**

Measuring

Best Practices for Measuring

- Always use a steel tape or a metal ruler for measuring.
- Always measure every window even though they look the same.
- Check for obstructions that could affect operation of the shade.
- For Inside Mount (jamb to jamb in a window or door, wall to wall in a room), give exact inside to inside width measurements, and top to bottom length measurements of the area to be covered.
- Measure the width in at least three places and specify the narrowest width.
- Measure the length in at least three places and specify the shortest length.
- Take two diagonal measurements. If there is a difference of 3/8" or more in diagonal measurements, outside mount is strongly recommended to avoid irregular light gaps.
- For Outside Mount, measure the exact width and height of the area to be covered.

Measuring for Manh Truc Flat and Hobbled Shades

Inside Measurement - Check the projection of the roman shade style ordered to determine minimum recess. A traditional style shade is **strongly recommended** for inside (jamb to jamb) installations. **DO NOT MAKE ANY ALLOWANCES.** The factory will make a 1/2" width deduction so that the shade will fit properly into the opening. To determine the finished length of the shade measure from the top of the jamb down to the sill (or bottom coverage point).

Outside Measurement - Check for any obstructions that require an installation modification for operational clearance. If your installation requires an additional projection for the outside bracket to allow for operational clearance, you will need to order longer projection brackets separately. Measure the exact width of the area to be covered. Specify this measure as an outside mount. No factory deductions will be made. To determine the finished length of the shade, measure from the top of where the shade is to be mounted down to the bottom coverage point.

Measuring for Manh Truc Roller Shades

Inside Measurement - Check the projection of the roller shade being ordered. For Roller Shades 50" or less in length, a 3 1/2" projection board is used; For Roller Shades greater than 50" in length, a 5 1/2" project board is used. **DO NOT MAKE ANY ALLOWANCES.** The factory will make a 1/8" width deduction so that the board will fit properly into the opening. The roller shade material is 1 1/4" less than the board width measurement. To determine the finished length of the shade measure from the top of the jamb down to the sill (or bottom coverage point).

Outside Measurement - Check for any obstructions that require an installation modification for operational clearance. For Roller Shades 50" or less in length, a 3 1/2" projection board is used; For Roller Shades greater than 50" in length, a 5 1/2" project board is used. The board width ordered is equal to the board width produced. The roller shade material is 1 1/4" less than the board width measurement so be sure to order a width wide enough to cover the entire window opening.

Measuring for Panel Track

Inside Measurement - For Panel Track to be installed inside an area (jamb to jamb, wall to wall), give exact inside width measurements, and top to bottom length measurements of the area to be covered. **DO NOT MAKE ANY ALLOWANCES.** The factory will make all deductions (1/8") so that the track will fit properly into the opening. The panels will clear the sill or floor approximately 3/8". Designate your measurements **INSIDE MOUNT.**

Warning: When Panel Tracks are installed as an Inside Mount, there **WILL BE** a 1/2" **LIGHT GAP** on the left and right sides. Consider drapery panels on each side of the opening to conceal the light gap.

Outside Measurement - Measure the exact width and height of the area to be covered. No allowances will be made by the factory for length. When measuring from the ceiling to the floor, a deduction of 1/2" is recommended, but **you must make this deduction.** For **outside mount Panel Track with a Cord Draw the finished track width is 1" greater** than the ordered width due to cord draw end caps. For **outside mount Panel Track with a Wand Draw the finished track width is 1/4" greater** than the ordered width. Designate your measurements **OUTSIDE MOUNT.** When measuring to cover a window, we recommend the Panel Track overlap the window by 3" to 6" on each side for privacy and light control.

Warning: When installing a Panel Track above the window frame, the track should be installed at least 2" above the frame or molding to allow the foot of the installation bracket to be properly mounted.

Measuring for Panel Drape

Inside Measurement - For Panel Drape to be installed inside an area (jamb to jamb in a window or door, wall to wall in a room), give exact inside width measurements, and top to bottom length measurements of the area to be covered. **DO NOT MAKE ANY ALLOWANCES.** The factory will make all deductions so that the track will fit properly into the opening. The Panel Drape will clear the sill or floor approx. 3/8". Designate your measurements **INSIDE MOUNT.**

Warning: For inside mount, the depth required for installation will vary based upon the stiffness of the material selected.

Outside Measurement - Measure the exact width and height of the area to be covered. No allowances will be made by the factory for length. When measuring from the ceiling to the floor, a deduction of 1/2" is recommended, but **you must make this deduction.** Designate your measurements **OUTSIDE MOUNT.** When measuring to cover a window, we recommend the Panel Drape overlap the window by 3" to 6" on each side for privacy and light control.

Warning: When installing a Panel Drape above the window frame, the track should be installed at least 2" above the frame or molding to allow the foot of the installation bracket to be properly mounted.

Brackets, Care & Cleaning, Advisories

Manh Truc Woven Shade Headrail & Hardware

- 2" deep x 1" high headrail.
- Available with 1", 2", 3 1/2" or 5 1/2" returns.
- Optional Turned headrail: 1" deep x 2" high (cord lock only).
- For outside mount, New York bracket is standard; L bracket by request at no charge. For 3 1/2" or 5 1/2" projection, angle irons are sent.
- For inside mount, 3" screws are included; New York bracket by request for no charge at the time of order.

Bracket Drawings

The type and size of bracket sent with a shade order is dependent on the headrail size and type of installation. Bracket drawings of the L bracket (both 2" and 1" headrail projection) and the New York style bracket are shown below. Spacer blocks are available if more projection is required (SP-31).

New York Bracket
2" headrail projection
OS Mount
1" wide
1 7/8" depth
RWC-60025

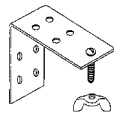

New York Bracket
Specialty/Ceiling Mount Bracket
IS Mount
1" wide
1 3/4" depth
RWC-60026
MUST be specified at time of order

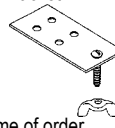

Angle Bracket - 2" headrail projection
2 1/8" depth
1" wide
1 1/2" high
56-2928-08



L Bracket - 1" headrail projection
1" depth
1/2" wide
1" high
13-10720



L Bracket - 3" headrail projection
3" depth
3/4" wide
3" high
8-595-0

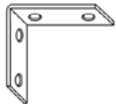

L Bracket - 4" headrail projection
4" depth
3/4" wide
4" high
8-596-0

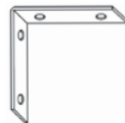

Hold Down Bracket
WWC-900205



Button Catch - Button # 702664
Receiver # B0-07000-034
Screw # TFP-04051-034



L Bracket for Panel Track
Inside and Outside Mount
2" high x 3 1/8" depth x 3/4" wide
PT-SV30



Swivel Bracket (Key) for Panel Track
Inside Mount
1/4" high x 2" depth x 2" wide
TP135-205



Installation Bracket for Panel Drape
Inside Clip 1 3/8" x 5/8"
Adjustable Outside Bracket
1 1/2" high, 2 7/8" to 4 1/4" deep
WB-53202-XX, 25 white or 65 brown

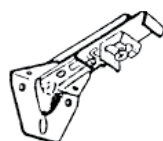

Care & Cleaning

- Light dusting is recommended for Manh Truc materials. Because the Manh Truc materials are "natural" and include grasses, reeds and bamboos, cleaning with water or any detergent is NOT recommended. Dusting with a vacuum attachment can be done with extreme care on low suction.
- Lining materials for Manh Truc can be spot cleaned using warm water and detergent. Do NOT immerse the lining in water.

Flame Retardant or Anti Microbial Coating

- Available for Manh Truc Flat and Hobbled Roman Shades, Roller Shades, Panel Track and Panel Drape Shades.
- A flame retardant or antimicrobial coating is available for all Manh Truc patterns. The Manh Truc custom product is fabricated and sent to an external facility for either process. Allow four to six weeks extra delivery time for this service.
- Contact Customer Service for a quote. Standard shipping is included.

Advisories

- Please examine all merchandise and packages for accuracy and make sure all parts, brackets, etc. are included **before** going on an installation. While we strive to make sure each order is exact and complete, we do occasionally make mistakes, and **we cannot be responsible for trip charges or reinstallation charges. Repairs or remakes must be requested within 30 days of invoice date.**
- Each Manh Truc Woven Shade is unique and constructed from all natural materials such as bamboo, wood, reeds and grasses. Slight cracks, wood imperfections and variations in color are inherent to natural products. Color variations may continue to change, lighten or mellow over time making each shade as distinctive as it is beautiful.
- Woven materials within a shade can have a slight bow or camber so that the horizontal lines or bottom hems might not be visually straight, even on shades of the same height. In addition, fold alignment can vary slightly from shade to shade.
- Because of the weight of the materials, shades tend to stretch slightly over time and may touch the sill on an inside installation.
- Most natural patterns do not provide privacy, especially at night. For complete privacy consider using the lining option or a liner shade.
- The natural grass or reed material may have a "grassy" or paint scent, especially after being enclosed during shipping.
- Manh Truc materials with horizontal patterns will NOT line up from shade to shade. We do not recommend multiple shades on one headrail with these patterns because the side-by-side shades will NOT align. The following patterns DO NOT have horizontal alignment from shade to shade:

Bacopa	Kaila	Lani	Sibu	Ulani
Caracas	Kato	Maka	Taipei	Waja
Hanoi	Khan	Malana	Taishan	Zhen
Jambu	Lada			

Manh Truc Color Line

Manh Truc Custom Woven Collection Color Line

Pattern Name	Color Name	Color #	Pattern Name	Color Name	Color #
Akela	Dawn	260	Lada	Blush	115
Akela	Malt	460	Lani	Fog	348
Akela	Smoke	802	Lani	Natural	540
Akela	White	885	Lani	Rice	690
Aris	Ginger	361	Lani	Smoke	802
Bacopa	Camel	139	Lea	Cashmere	257
Batang	White	885	Lea	Dawn	260
Bayani	Shell	760	Lea	Desert	270
Beijing	Desert	270	Maka	Fog	348
Beijing	Dusk	298	Malana	Coconut	014
Bengali	Grass	119	Malana	Pewter	083
Caracas	Ginger	361	Malie	Snow	805
Caracas	Teak	758	Miya	Azure	058
Chakra	Desert	270	Miya	Cornsilk	231
Chakra	Malt	460	Miya	Moonlight	552
Chakra	Pecan	615	Miya	Toffee	841
Chakra	Smoke	802	Naoki	Dove	143
Chakra	White	885	Naoki	Nutmeg	543
Chinda	Blush	115	Naoki	Malt	460
Chinda	Camel	139	Naoki	White	885
Chinda	Taupe	840	Naoki	Whitewash	862
Chinda	White	885	Okalani	Fog	348
Dieu	Oatmeal	556	Okalani	Pumice	607
Dieu	White	885	Okalani	Tiger	847
Dynasty	Teak	758	Okalani	Tortoise	118
Hanoi	Camel	139	Osaka	Jute	489
Jambu	Adobe	005	Sapporo	Malt	460
Jambu	Rye	716	Sapporo	White	885
Jambu	Smoke	802	Sasarido	Ebony	318
Jambu	White Sands	886	Sibu	Natural	540
Jilin	Natural	540	Srilanka	Mink	216
Kaila	Greige	827	Taipei	Straw	825
Kaila	Sand Dunes	042	Taishan	Mocha	516
Kaliko	Island	401	Tomiko	Walnut	891
Kaliko	Natural	540	Ulani	Walnut	891
Kaliko	Seagrass	728	Waja	Ebony	318
Kaliko	Smoke	802	Waja	Malt	460
Kato	Mink	216	Waja	Natural	540
Kazuki	Natural	540	Zhen	Jute	489
Khan	Driftwood	291			
Kwan	Warm White	883			

Manh Truc Linings

Light Filtering	Snowflake	168
Light Filtering	Silver	780
Light Filtering	Midnight	505
Light Filtering	Gold Dust	368
Light Filtering	Iceberg	421
Light Filtering	Coffee Bean	926
Opaque	Snow	805
Opaque	Cream	235
Opaque	Birch	411
Opaque	Buff	130
Opaque	Slate	800
Opaque	Ebony	318

Manh Truc Bandings

Fabric Banding	Aloe	011
Fabric Banding	Bone	120
Fabric Banding	Cocoa	208
Fabric Banding	Coin	203
Fabric Banding	Granite	375
Fabric Banding	Ivory	420
Fabric Banding	Linen	455
Fabric Banding	Spruce	822
Fabric Banding	Teal	845
Fabric Banding	Truffle	857
Fabric Banding	Tuxedo	854
Fabric Banding	Winter	898
Fabric Banding is 1 1/4" or 3" wide		
Twill Banding	Basil	021
Twill Banding	Black	995
Twill Banding	Claret	875
Twill Banding	Cocoa	290
Twill Banding	Khaki	559
Twill Banding	Loden	597
Twill Banding	Natural	175
Twill Banding	Nutmeg	270
Twill Banding	Sand	566
Twill Banding	Smoke	802
Twill Banding	Spa	806
Twill Banding	Taupe	166
Twill Banding	White	010
Twill Banding is 1 1/4" or 3" wide		

Manh Truc Characteristics

It is critical that your customers understand the natural characteristics of Manh Truc Woven Shades. The "Perfectly Natural" card is packaged with each Manh Truc shade. Please be sure to leave this important insert with your customer.

Perfectly Natural

Woven Shades & Custom Shades

Woven shades and custom shades offer the natural colors and textures of genuine woods, reeds, grasses, palm leaves, and bamboo materials. The finest native materials in shades contain some variations in color and hue. Patterns with bamboo, for example, may appear green at the time of installation, but they slowly age to a beige-brown hue.

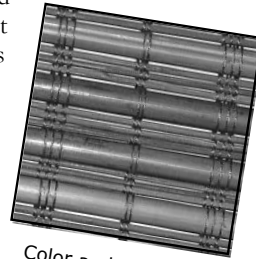

Color and Hue

Paint and yarn color variations are present in all natural shade patterns, too. For the best color match, all shades to be installed in the same room should be ordered at the same time. Slight variations are still possible within the same order, particularly on bamboo.

Some natural patterns offer slight differences in grain and texture, especially in materials containing knots or slight surface cracks.

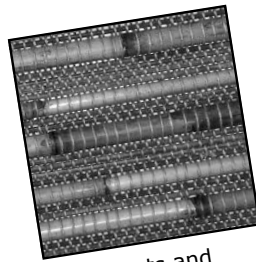

Knots and Cracks

Natural variations in the materials and the loose weave of the shades can prevent perfect alignment of the horizontal lines.

The natural woven materials can have a slight bow or camber so that the horizontal lines or bottom hems might not be perfectly straight. In addition, fold alignment can vary slightly, even on shades that are the same height.

Because of the weight of the materials, the shades tend to stretch slightly over time, and the woven wood shades might eventually touch the window sill on an inside installation.

The natural reed or grass material may also have a "grassy" or paint scent, especially after being enclosed during shipping.

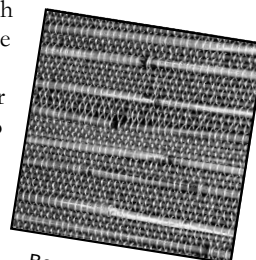

Bow and Camber

Most natural patterns do not provide complete privacy, and this is especially apparent at night. If woven wood shades will be installed in a bedroom, bathroom, or another application requiring complete privacy, shades should be ordered to include the lining option.



LAFAYETTE WARRANTY

Lafayette Venetian Blind, Inc. warrants to the original purchaser that its products, properly measured, installed and maintained in the window/door will be free from defect in materials and workmanship from the date of sale to the original purchaser for the period shown below, based upon product type.

Allure Transitional Shades	Lifetime Limited	Motorized Systems (excluding batteries)	5 years
Classic Collection Aluminum Blinds	Lifetime Limited	exception: Auto Wand, EZ Charge V 1.0	1 year
Discoveries Verticals Louvers and Track	Lifetime Limited	Auto Wand, EZ Charge V 2.0	5 years
Fidelis Composite Wood Blinds	Lifetime Limited	Parasol Cellular Shades	Lifetime Limited
Genesis Shades	Lifetime Limited	Sheer Visions Fabric	3 years
Heartland Woods	Lifetime Limited, 3 yrs Finish	Soft Fashions	3 years
Manh Truc Woven Shades	Lifetime Limited	Tenera Sheer Shadings	Lifetime Limited
Marquis Shutters	Lifetime Limited	Wonderwood Faux Wood Blinds	Lifetime Limited
		Woodland Harvest Shutters	Lifetime Limited, 3 yrs Finish

The obligation of Lafayette Venetian Blind, Inc. and its dealers is limited to repair or replacement of the internal mechanisms, components and brackets found to be defective when the product is returned to Lafayette Venetian Blind, Inc. at the expense of the original purchaser within the warranty period stated above. Repairs will be made with like or similar parts. Discontinued components or colors will be replaced with closest equivalent current product.

Operational cords on Lafayette products are warranted for 7 years from the date of purchase. All repairs and remakes will conform to current child safety requirements. If the repair or remake is outside the 7 year operational cord warranty then any costs to conform to child safety guidelines are the responsibility of the dealer. Fabric delamination is also covered within the warranty period stated above.

This warranty does NOT include any conditions caused by normal wear and tear or damages resulting from accidents, alterations, misuse, abuse, misapplication, exposure to the elements (sun damage, wind/water/moisture) and discoloration or fading over time). Failure to follow instructions for measurement, installation, cleaning or maintenance void the warranty. The product can only be used in the window/door for which it was originally purchased. Lafayette Venetian Blind, Inc. will not be liable for trip charges, measuring, disassembly, removal, reassembly or reinstallation of this product, nor for damage or loss to other property.

This warranty is exclusive and in lieu of all other obligations, liabilities, or warranties. This warranty gives you specific legal rights. You may have other rights which vary from state to state. In some states the exclusion or limitation of incidental or consequential damages may not apply.

To obtain warranty service, contact an authorized Lafayette dealer. The dealer will work with Lafayette Venetian Blind, Inc. to promptly repair or replace any defective parts or components without charge. Warranty claims must be accompanied by proof of purchase.

DISCLAIMER AND LIMITATION OF WARRANTIES AND REMEDIES

THERE ARE NO WARRANTIES WHICH EXTEND BEYOND THE DESCRIPTION ON THE FACE HEREOF.

THE WARRANTIES SET FORTH IN THIS "LAFAYETTE WARRANTY" STATEMENT ARE IN LIEU OF ALL OTHER WARRANTIES, EXPRESSED OR IMPLIED, INCLUDING WITHOUT LIMITATION ALL WARRANTIES OF MERCHANTABILITY OR FITNESS FOR A PARTICULAR PURPOSE, WHICH WARRANTIES ARE SPECIFICALLY DISCLAIMED BY LAFAYETTE VENETIAN BLIND, INC.

THE SOLE OBLIGATION OF LAFAYETTE VENETIAN BLIND, INC., AND THE SOLE REMEDY OF ANY ORIGINAL PURCHASER FOR ANY CLAIMED BREACH OF WARRANTY, DEFECT OR NONCONFORMITY OF PRODUCT (REGARDLESS OF THE NATURE OF SUCH CLAIM, AND INCLUDING CLAIMS OF BREACH OF WARRANTY, CONTRACT, NEGLIGENCE, STRICT LIABILITY, AND ALL OTHER CLAIMS) SHALL BE THE ORIGINAL PURCHASER'S RIGHT TO RETURN ANY NONCONFORMING PRODUCT TO LAFAYETTE VENETIAN BLIND, INC., IN EXCHANGE FOR REPAIR OR REPLACEMENT OF SAID PRODUCT IN ACCORDANCE WITH THE LIMITED EXPRESS WARRANTY STATED IN THIS "LAFAYETTE WARRANTY." IN NO EVENT SHALL LAFAYETTE VENETIAN BLIND, INC., BE LIABLE FOR DAMAGES, WHETHER DIRECT, CONSEQUENTIAL OR INCIDENTAL, TO ANY ORIGINAL PURCHASER OR ANY OTHER PARTY, ARISING OUT OF SALE OR USE OF PRODUCTS SOLD BY LAFAYETTE VENETIAN BLIND, INC., WITH THE LIMITED EXPRESS WARRANTIES SET FORTH IN THIS "LAFAYETTE WARRANTY" STATEMENT.

Lafayette will, at our discretion, repair or replace the window fashions product or components found to be defective.
Product warranties DO NOT imply replacement of the product.

Product returned to Lafayette must comply with the Return Product Packaging Policy.
Lafayette will not be responsible for removal charges, reinstallation charges or shipping costs incurred.

Find the on-line Product Registration Form at www.lafayetteinteriorfashions.com/Resources/Warranty & Registration

LAFAYETTE PRODUCT OFFERING

Blinds

Classic Collection Aluminum Blinds (1/2", 1", 2")
Heartland Woods® (1" and 2")
Fidelis® Composite Wood Blinds (2" and 2 1/2")
Wonderwood® Faux Wood Blinds (2" and 2 1/2")
Discoveries Vertical Blinds
Sheer Visions™ Verticals

Shades

Allure® and Allure Sundown® Transitional Shades
Allure® Modернаire™ Transitional Shades
Allure® Couplitaire™ Transitional Shades
Allure® Visionaire™ Transitional Shades
Genesis® Window Shades & Season-View™ Shades
Genesis® Panel Track Shades
Manh Truc® Custom Woven Shades
Manh Truc® Panel Track & Panel Drape
Parasol® Cellular Shades
Tenera™ Sheer Shadings

Shutters

Woodland Harvest® Custom Shutters
Marquis™ Shutters
Palladian Shelf

Draperies, Etc.

Interior Masterpieces®
Draperies
Fabric Shades
Valances
Cornices
Bedding
Shade Masterpieces™
Select Masterpieces® Fabrics - Cut & Piece Goods
Kirsch® Drapery Hardware
Lafayette Drapery Hardware
Lafayette Installation Tools & Supplies
Embellishment Trimmings
Window Shade Products
Redi-Shade Temporary Shade



National Headquarters

3000 Klondike Road

P.O. Box 2838

West Lafayette, IN 47996-2838

Local Telephone	765/464-2600
Cust Svc/Order Entry	800/342-5523
Cust Svc/OE FAX	765/464-2680
Administration FAX	765/423-2402
Credit Department	800/944-4582



www.lafayetteinteriorfashions.com